



Drawing No.	Rev.	Date	Page
EL-B02L1200-DSV-D4846W	B	2018/08/22	1/8

APPROVAL SHEET

Part No: **EL-B02L1200-DSV-D4846W**

NOTE :
WIDE-BAND

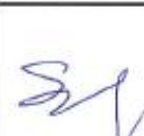
MAKER			CUSTOMER	
				
R&D	QA	Sales	Checked	Approved
				

Prepared	Checked	Approved
Rachel Lee	Evan Chang	Kenneth Wu

Drawing No.	Rev.	Date	Page
EL-B02L1200-DSV-D4846W	B	2018/08/22	2/8

Description of P/N No.

EL - B02L1200 - DSV - D4846W

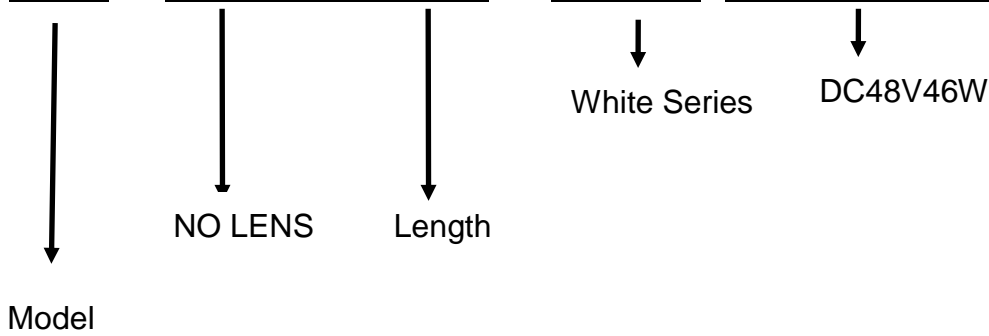

Description of Lot.

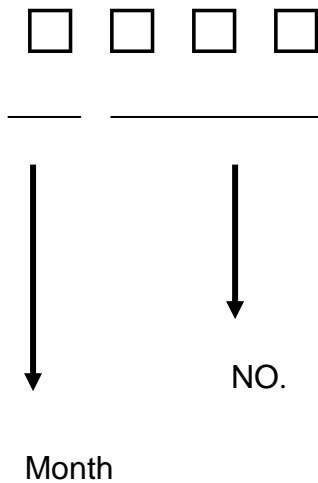

Solidlite Corp. 

P/N : _____

Lot : _____

Date: _____ . Rank: _____

Q'ty : _____ . QA : _____

Drawing No.	Rev.	Date	Page
EL-B02L1200-DSV-D4846W	B	2018/08/22	3/8

Specification for Approval

Product : LED FLAT PANEL

Part Number : EL-B02L1200-DSV-D4846W

Applications

Area: Indoor use only

Purpose:

Plant Growing Lighting , Office Lighting , Meeting Room Lighting , Shop Lighting ,
Classroom Lighting , Factory Lighting ,

Product Overview

※ Aluminum heat-sink base can dissipate more heat and lead to a longer life span.

Specification ※For Plant Factory use only.

※Remember not to use the device underwater.

Outline Dimension: (L)1240 (±4.5mm)mm (W) 100 (±4mm)mm (H) 15.7 (±0.3mm)mm

Input Voltage /Current : DC48V/960mA

Operating Temperature / Relative Humidity: 0°C~35°C / 20%~80%RH

(Warranty Conditions)

Storage Temp Range / Relative Humidity: -20°C ~ 60°C / 20% ~ 80 %RH

Heat-Sink Surface Temp: <60 °C

Life Expectancy of Driver : 40000hrs

Life Expectancy of LEDs :40000hrs

Safety warning

Cautions:

Don't drop the luminaire on the ground since the luminaire will be damaged

Don't expose this product at the high temperature and high humidity environment

Warranty

Warranty 1years.

Should not have an adverse early.

Within one years, must be greater than the specification brightness light efficiency of 70%.



Waterproof and dust tight IP66*

*Claims and Test Results:The claims are mainly based on results from tests conducted by SGS.(Report No.:OC-2016-300041)

Chromaticity Coordinate

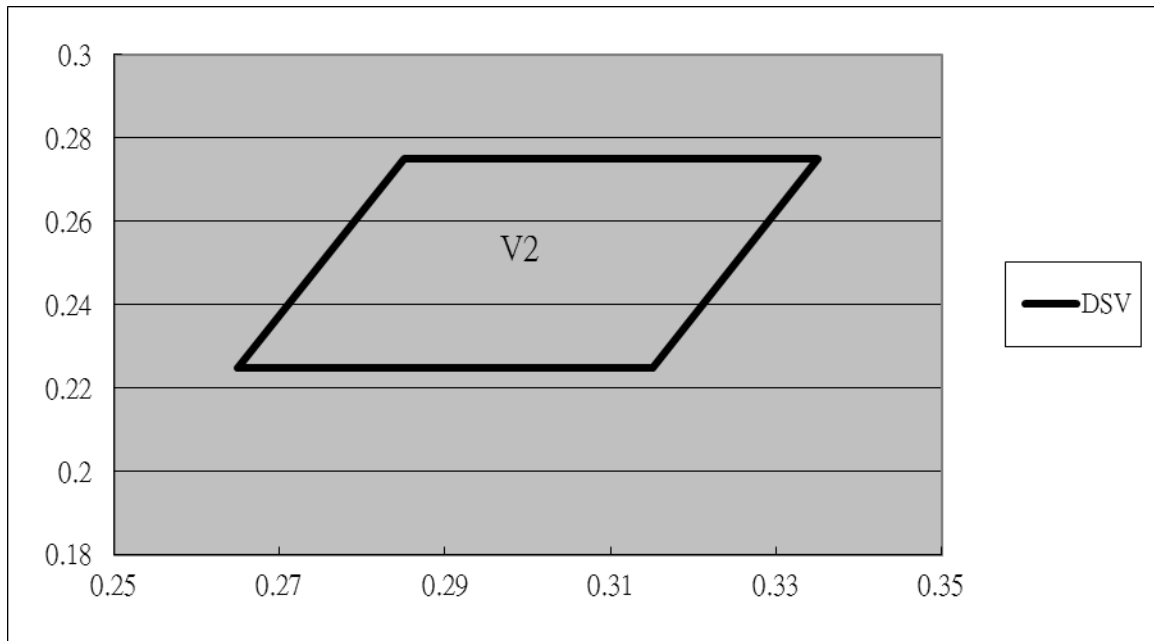

CIE X-Y :

V1---(0.265,0.225) (0.285,0.275) (0.335,275) (0.315,0.225)

Electronic Charateristic

Absolute Maximum Ratings at T_a=25°C

Item	EL-B02L1200-DSV-D4846W
LED Quantity	224pcs
DC V input	48V
DC I input	960mA
Power Dissipation	46w
Heat-Sink Spec.	Aluminum
PCB Spec.	FR4
L/W/H	1240mm (±5mm)/100mm(±4mm)/15.7mm(±0.3mm)
Net weight	1000g±200g

Product size & Photo

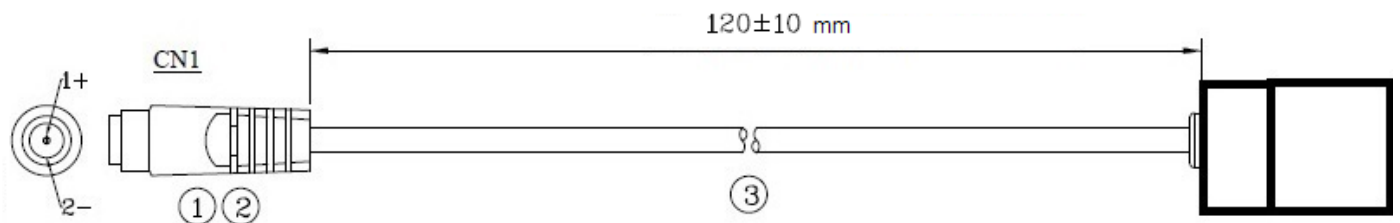
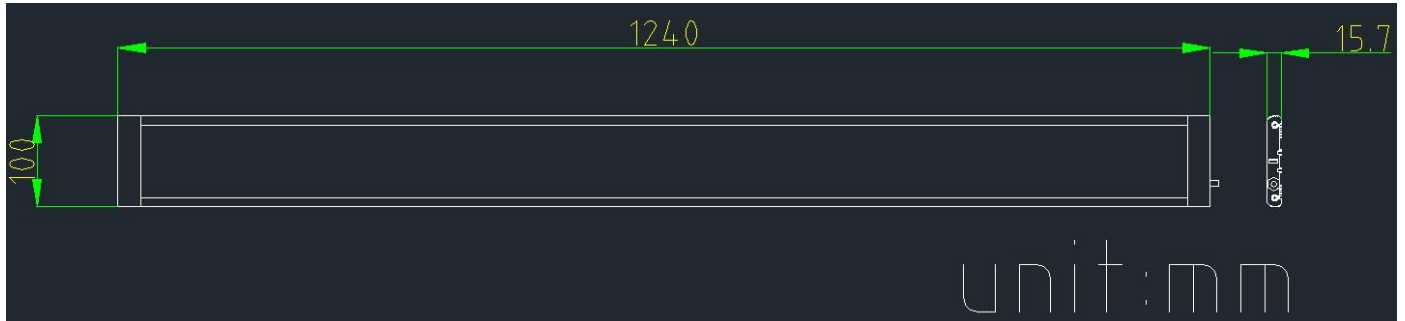

3	CABLE	UL2464#24*2C(STD) OD:3.5mm	1	BLACK(0)
2	PLASTIC	PVC45P/80°C		BLACK(0)
1	DC JACK	(5.5*2.1mm)DC-0236-3	1	金度金泉
NO	PART NAME	PART NO	Q'TY	COLOR



Typical Internal Equivalent Circuits

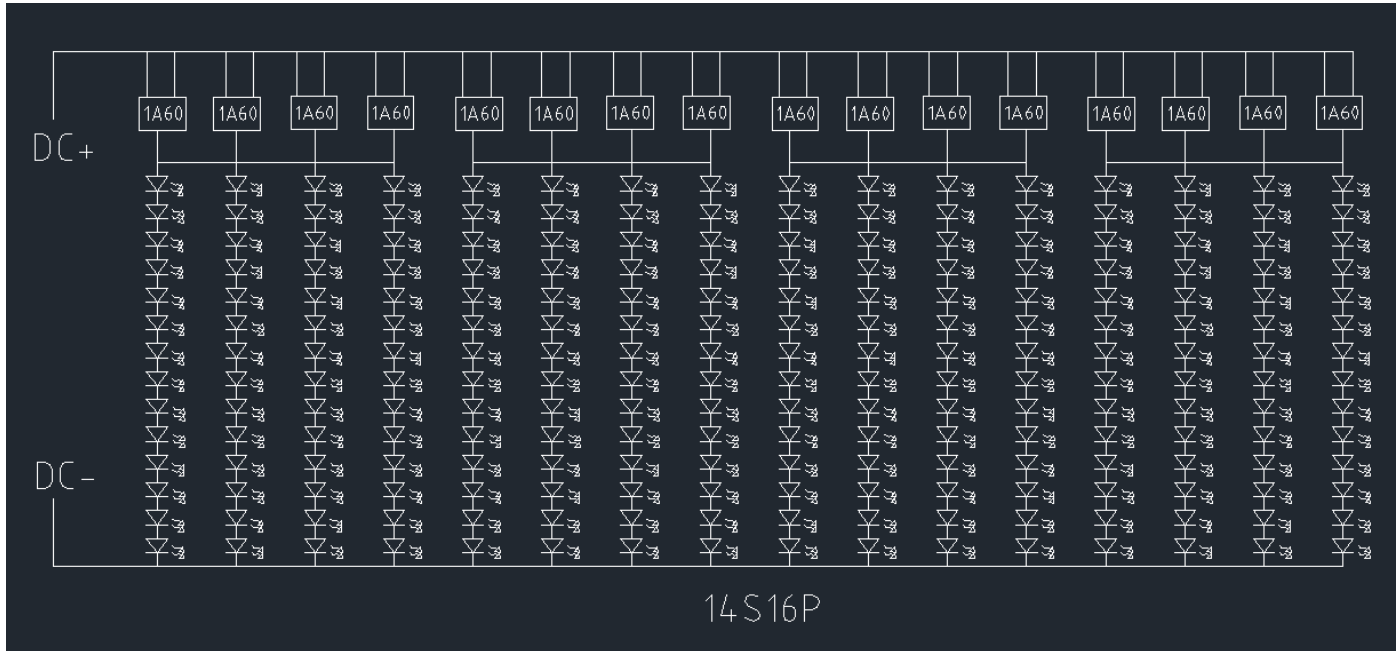

Label Format

SOLIDLITE	EL-B02L1200-DSV-D4846	輸入電圧: DC48V	1531
詮興開發科技股份有限公司	LED Flat Panel 48V46W LED平板燈48V46W	消耗功率:	MADE IN TAIWAN
		輸入電流:	

Optical Characteristic

Item	EL-B02L1200-DSV-D4846W
Viewing Angle	120°(±10%)
μMol/s*m ² (The center of the amount of survey)	120±20% @ 30cm(center) (without Linear fresnel film)
Light recipe	DSV
CRI	>80

Package information

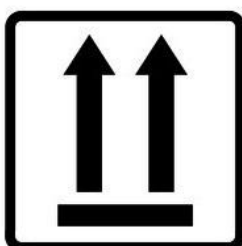
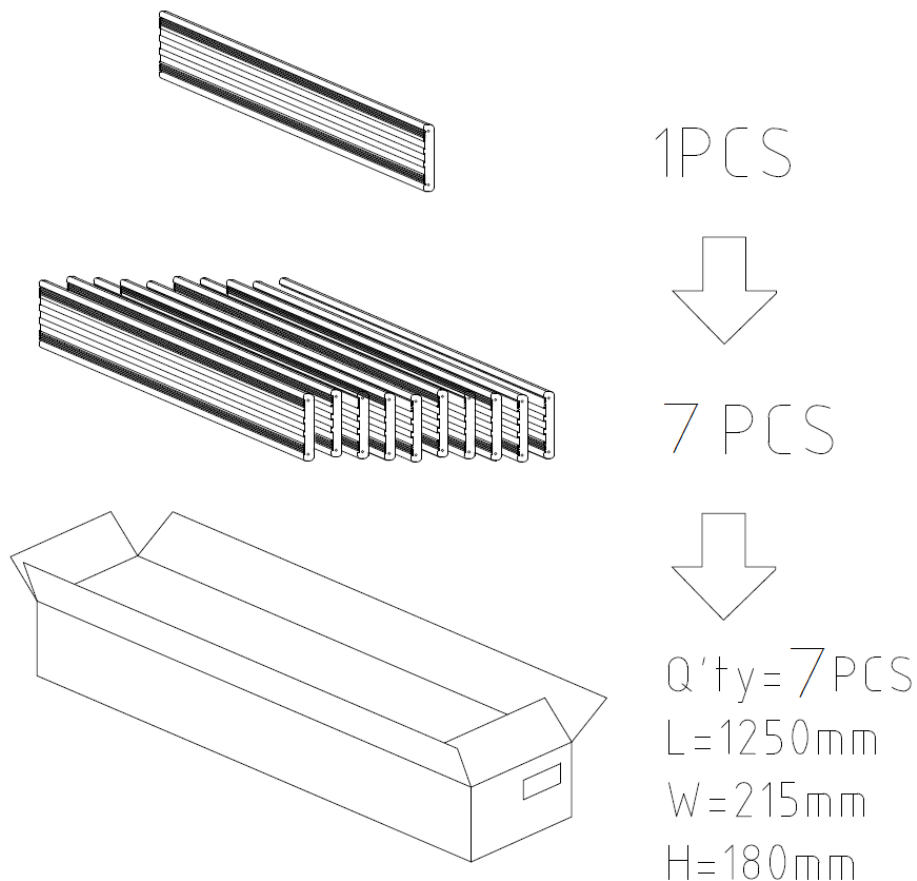

Drawing No.	Rev.	Date	Page
EL-B02L1200-DSV-D4846W	B	2018/08/22	8/8

Fitting Part



Use the illustration:

