

Drawing No.	Rev.	Date	Page
EL-B02L1200-DSC-D4846WE	A	2019/07/01	1/9



APPROVAL SHEET

Part No: **EL-B02L1200-DSC-D4846WE**

NOTE :

WIDE-BAND

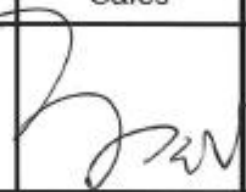

MAKER			CUSTOMER	
				
R&D	QA	Sales	Checked	Approved
				

Prepared	Checked	Approved
Rachel Lee	Evan Chang	Kenneth Wu

Drawing No.	Rev.	Date	Page
EL-B02L1200-DSC-D4846WE	A	2019/07/01	2/9

Description of P/N No.

EL - B02L1200 - DSC - D4846WE

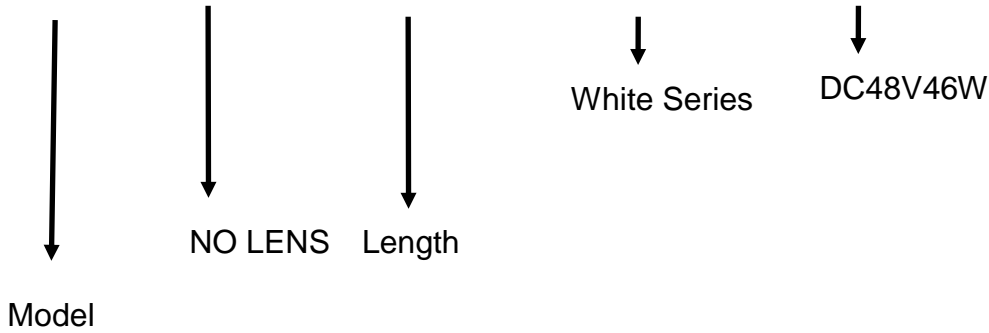

Description of Lot.

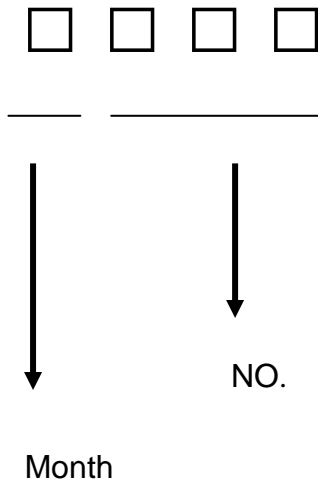

Solidlite Corp. 

P/N : _____

Lot : _____

Date: _____ . Rank: _____

Q'ty : _____ . QA : _____

Drawing No.	Rev.	Date	Page
EL-B02L1200-DSC-D4846WE	A	2019/07/01	3/9

Specification for Approval

Product : LED FLAT PANEL

Part Number : EL-B02L1200-DSC-D4846WE

Applications

Area: Indoor use only

Purpose:

Plant Growing Lighting ,Office Lighting , Meeting Room Lighting , Shop Lighting ,
Classroom Lighting , Factory Lighting ,.....

Product Overview

※ Aluminum heat-sink base can dissipate more heat and lead to a longer life span.

Specification ※For Plant Factory use only.

※Remember not to use the device underwater.

Outline Dimension: (L)1240 (±2.5mm)mm (W) 100 (±2.5mm)mm (H) 15.7 (±0.5mm)mm

Input Voltage /Current : DC48V/960mA

Operating Temperature / Relative Humidity: 0°C~35°C / 20%~80%RH

(Warranty Conditions)

Storage Temp Range / Relative Humidity: -20°C ~ 60°C / 20% ~ 80 %RH

Heat-Sink Surface Temp: <60 °C

Life Expectancy of Driver : 40000hrs

Life Expectancy of LEDs :40000hrs

Safety warning

Cautions:

Don't drop the luminaire on the ground since the luminaire will be damaged

Don't expose this product at the high temperature and high humidity environment

Warranty

Warranty 1years.

Should not have an adverse early.

Within 1 years, must be greater than the original brightness light efficiency of 80%.

Chromaticity Coordinate

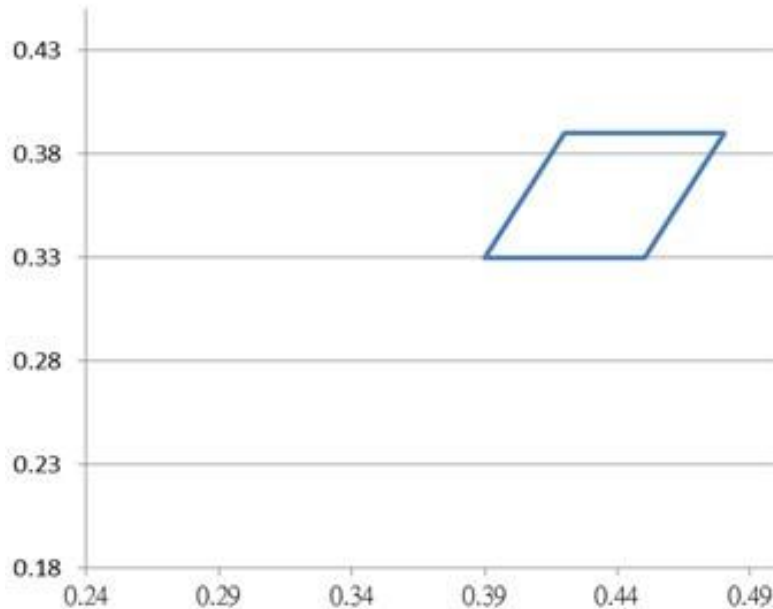

CIE X./Y : DSC --- (0.39, 0.33) (0.42, 0.39) (0.48, 0.39) (0.45, 0.33)

Electronic Characteristic

Absolute Maximum Ratings at T_a=25°C

Item	EL-B02L1200-DSC-D4846WE
LED Quantity	240pcs
DC V input	47~50V
DC I input	960mA±10%
Power Dissipation	46w±10%
Heat-Sink Spec.	Aluminum
PCB Spec.	FR4
L/W/H	1240mm (±2.5mm)/100mm(±2.5mm)/15.7mm(±0.5mm)
Net weight	1350g±50g

Drawing No.	Rev.	Date	Page
EL-B02L1200-DSC-D4846WE	A	2019/07/01	5/9

Product size & Photo

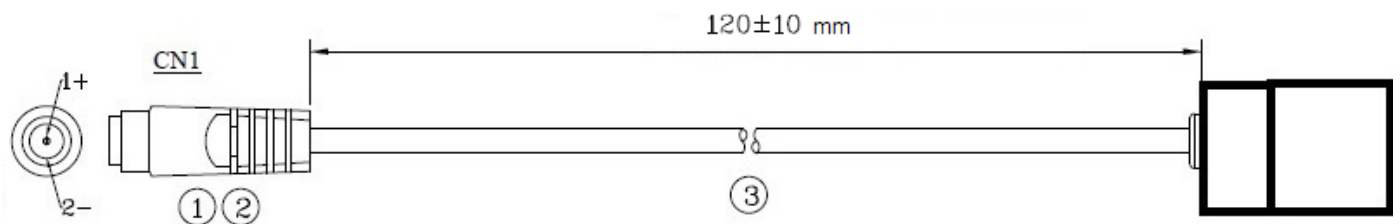

3	CABLE	UL2464#24*2C(STD) OD:3.5mm	1	BLACK(0
2	PLASTIC	PVC45P/80°C		BLACK(0
1	DC JACK	(5.5*2.1mm)DC-0236-3	1	金度金泉
NO	PART NAME	PART NO	Q'TY	COLOR



Drawing No.	Rev.	Date	Page
EL-B02L1200-DSC-D4846WE	A	2019/07/01	6/9

Typical Internal Equivalent Circuits

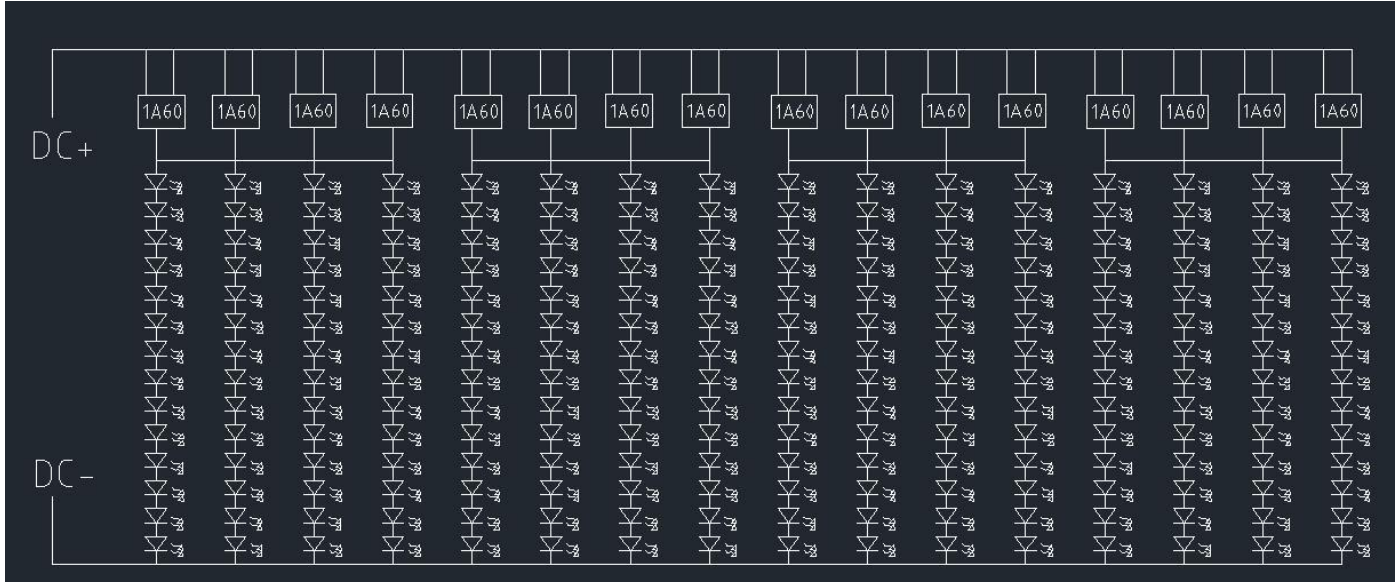

Label Format

SOLIDLITE 詮興開發科技股份有限公司	EL-B02L1200-DSC-D4846WE LED Flat Panel 48V46W LED平板燈48V46W	輸入電圧: DC48V 消耗功率: 46.08W 輸入電流: 0.96A	##:Year ##:Week 1531
		MADE IN TAIWAN BM78027 (BG)	Lot number CIE Rank

Label Location:

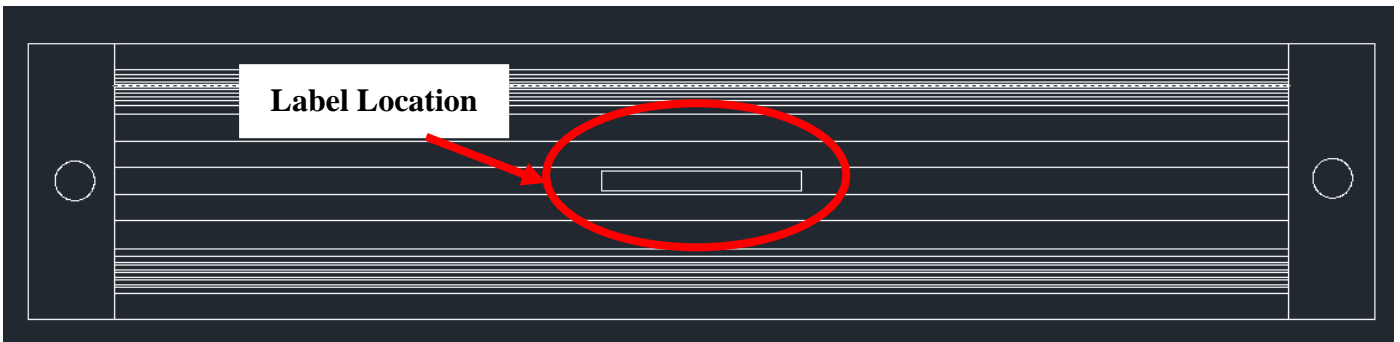

Optical Characteristic

Item	EL-B02L1200-DSC-D4846WE
Viewing Angle	108°(W)~120°(L)
$\mu\text{Mol/s}\cdot\text{m}^2$ (The center of the amount of survey)	120±20% @30cm(center) (without Linear fresnel film) (Measurement device model : HD 2102.2 Made in Italy)
Light recipe	DSC
Dimming & Protection Requirements	According to power supply
Waterproof IP ratings	IP66 *Claims and Test Results:The claims are mainly based on results from tests conducted by SGS.(Report No.:OC-2016-300041)

Light distribution curve

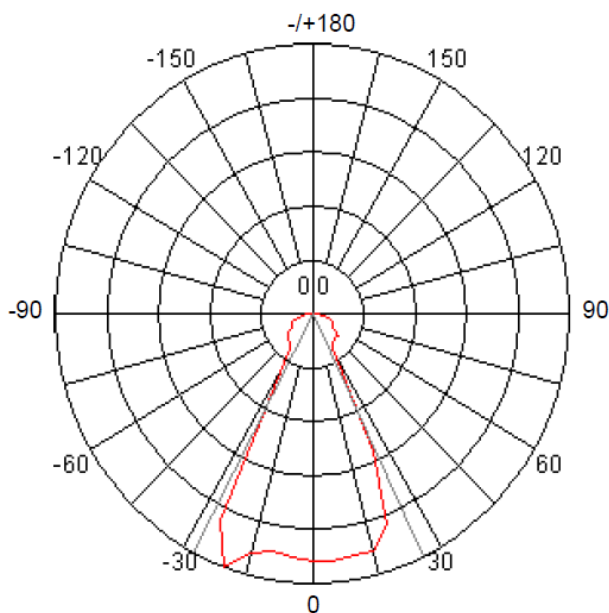

Average beam angle(50%):53.62°

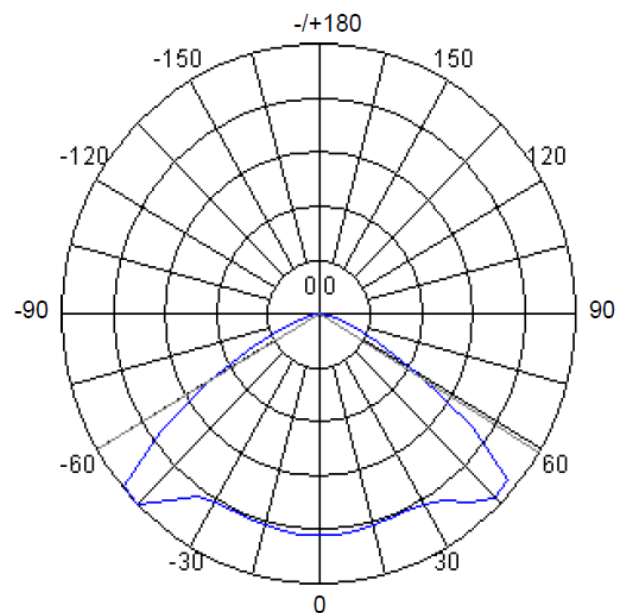

Average beam angle(50%):119.01°

Drawing No.	Rev.	Date	Page
EL-B02L1200-DSC-D4846WE	A	2019/07/01	8/9

Package information

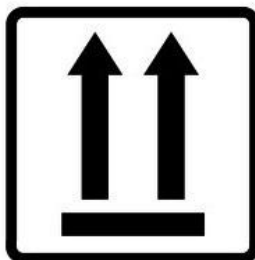
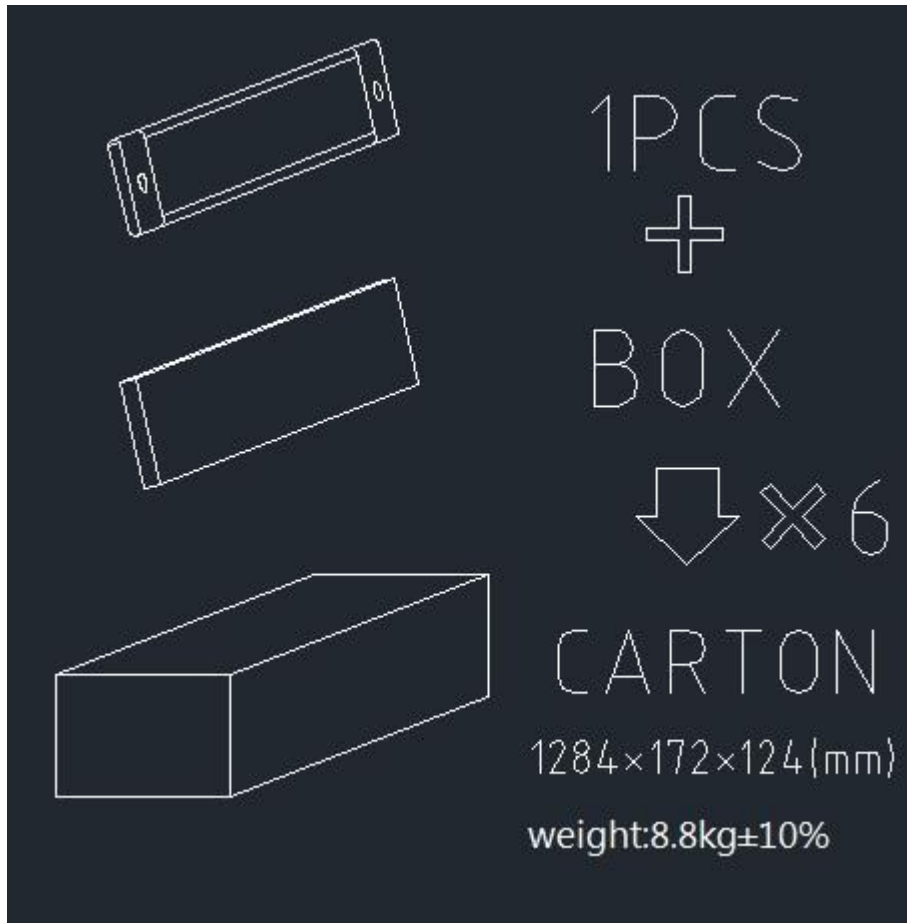

Drawing No.	Rev.	Date	Page
EL-B02L1200-DSC-D4846WE	A	2019/07/01	9/9

Fitting Part

L-HOLDER 2set(4PCS)



Use the illustration:

