





Drawing No.	Rev.	Date	Page
EL-B02L0300-DSB-D2410W	B	2018/11/26	1/8

APPROVAL SHEET

Part No: **EL-B02L0300-DSB-D2410W**

NOTE :
WIDE-BAND

MAKER			CUSTOMER	
				
R&D	QA	Sales	Checked	Approved
				

Prepared	Checked	Approved
Rachel Lee	Evan Chang	Kenneth Wu

Drawing No.	Rev.	Date	Page
EL-B02L0300-DSB-D2410W	B	2018/11/26	2/8

Description of P/N No.

EL - B02L0300 - DSB - D2410W

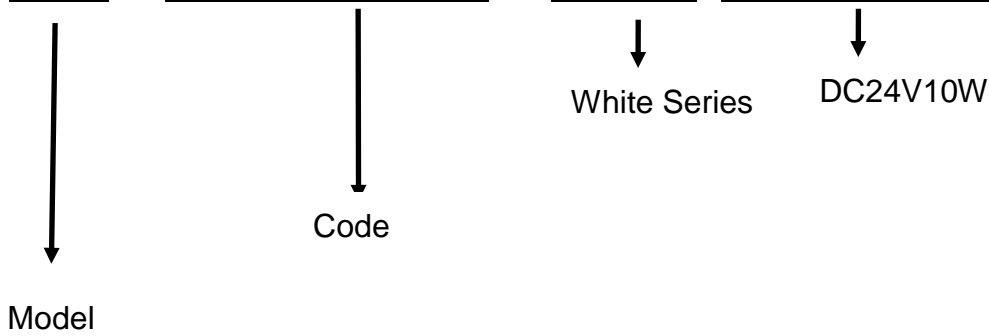

Description of Lot.

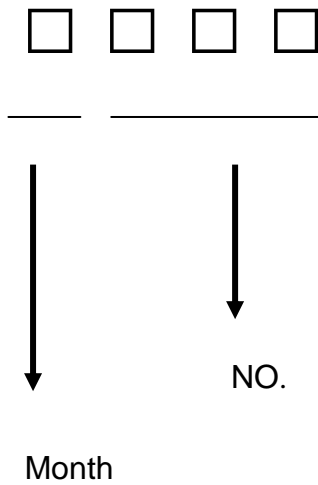

Solidlite Corp. 

P/N : _____

Lot : _____

Date: _____ . Rank: _____

Q'ty : _____ . QA : _____

Drawing No.	Rev.	Date	Page
EL-B02L0300-DSB-D2410W	B	2018/11/26	3/8

Specification for Approval

Product : LED FLAT PANEL

Part Number : EL-B02L0300-DSB-D2410W

Applications

Area: Indoor use only

Purpose:

Plant Growing Lighting , Office Lighting , Meeting Room Lighting , Shop Lighting ,
Classroom Lighting , Factory Lighting ,

Product Overview

※ Aluminum heat-sink base can dissipate more heat and lead to a longer life span.

Specification ※For Plant Factory use only.

※Remember not to use the device underwater.

Outline Dimension: (L)300 (±5mm)mm (W) 100 (±4mm)mm (H) 15.7 (±0.3mm)mm

Input Voltage /Current : DC24V/400mA

Operating Temperature / Relative Humidity: 0°C~35°C / 20%~80%RH
(Warranty Conditions)

Storage Temp Range / Relative Humidity: -20°C ~ 60°C / 20% ~ 80 %RH

Heat-Sink Surface Temp: <60 °C

Life Expectancy of Driver : 40000hrs

Life Expectancy of LEDs :40000hrs

Safety warning

Cautions:

Don't drop the luminaire on the ground since the luminaire will be damaged

Don't expose this product at the high temperature and high humidity environment

Warranty

Warranty 1years.

Should not have an adverse early.

Within one years, must be greater than the specification brightness light efficiency of 70%.



Waterproof and dust tight IP66*

*Claims and Test Results:The claims are mainly based on results from tests conducted by SGS.(Report No.:OC-2016-300041)

Chromaticity Coordinate

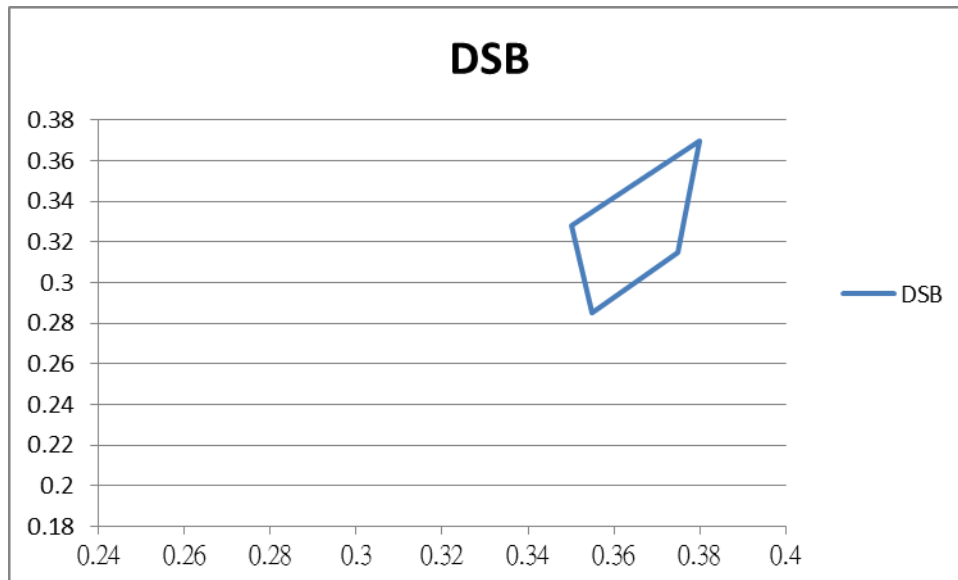

CIE X./Y :

B1 --- (0.350, 0.328) (0.380, 0.370) (0.375, 0.315) (0.355, 0.285)

Electronic Charateristic

Absolute Maximum Ratings at T_a=25°C

Item	EL-B02L0300-DSB-D2410W
LED Quantity	84pcs
DC V input	24V
DC I input	400mA
Power Dissipation	10w
Heat-Sink Spec.	Aluminum
PCB Spec.	FR4
L/W/H	300mm (±5mm)/100mm(±4mm)/15.7mm(±0.3mm)
Net weight	300g±50g

Drawing No.	Rev.	Date	Page
EL-B02L0300-DSB-D2410W	B	2018/11/26	5/8

Product size & Photo

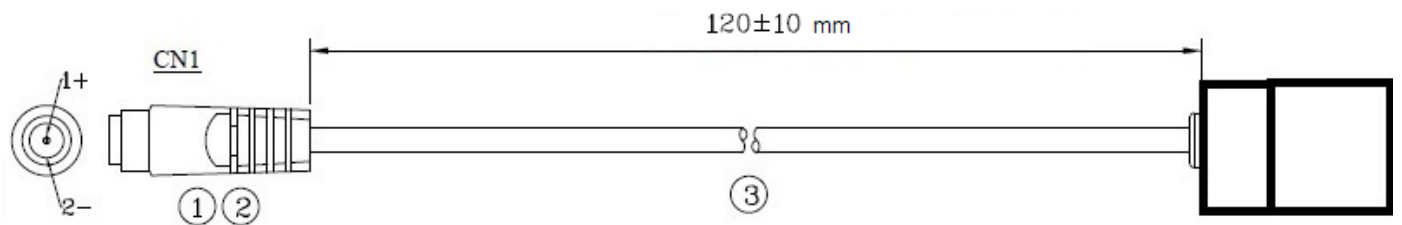
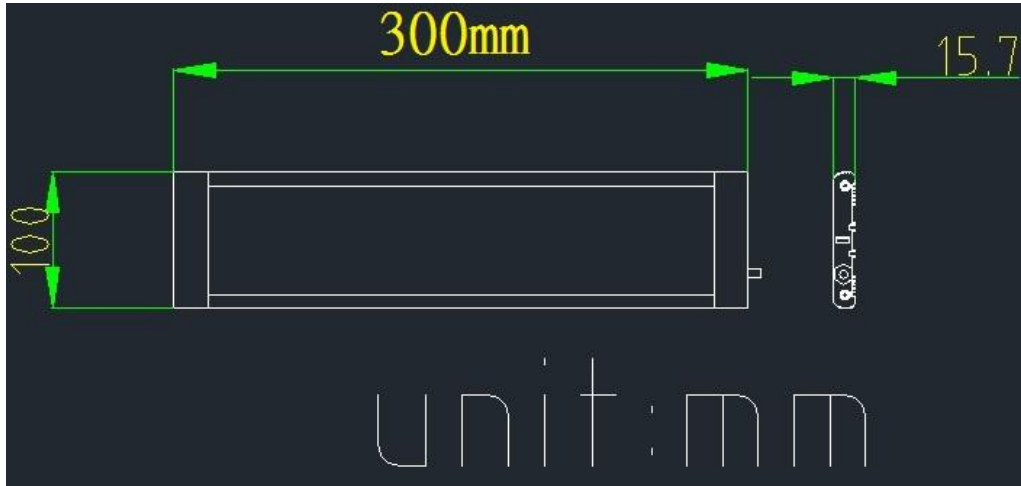

3	CABLE	UL2464#24*2C(STD) OD:3.5mm	1	BLACK(0
2	PLASTIC	PVC45P/80°C		BLACK(0
1	DC JACK	(5.5*2.1mm)DC-0236-3	1	鍍度金泉
NO	PART NAME	PART NO	Q'TY	COLOR



Drawing No.	Rev.	Date	Page
EL-B02L0300-DSB-D2410W	B	2018/11/26	6/8

Typical Internal Equivalent Circuits

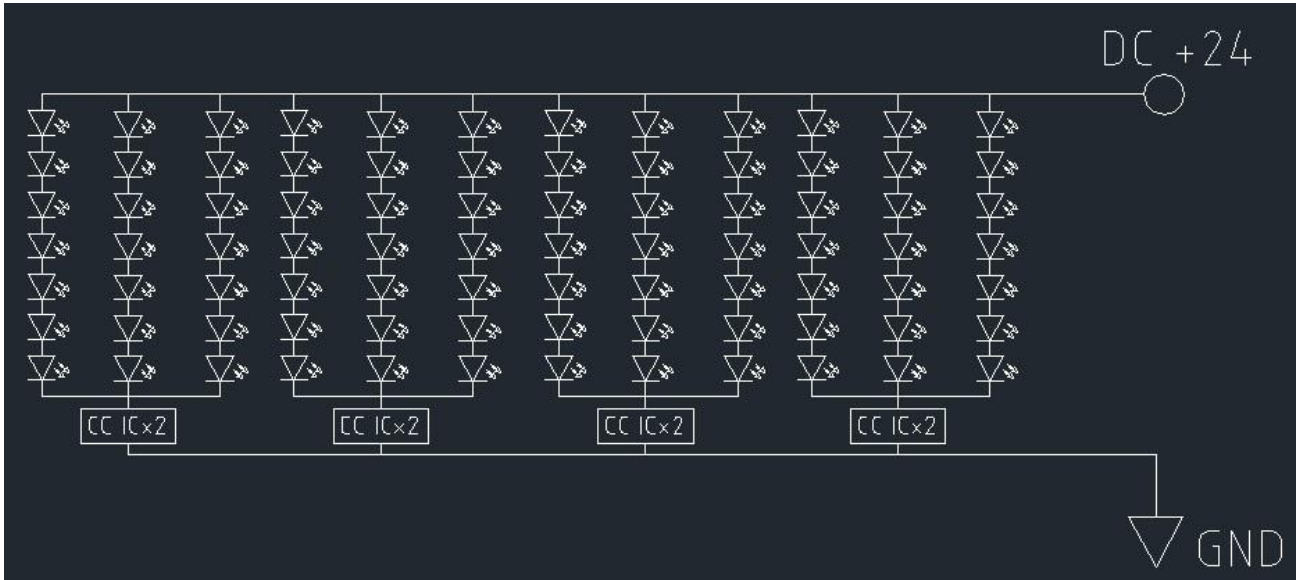

Label Format

SOLIDLITE	EL-B02L0300-DSB-D2410	輸入電壓DC24V 1531
詮興開發科技股份有限公司	LED Flat Panel 2410W LED平板燈 2410W	消耗功率:10W
		輸入電流: MADE IN TAIWAN

Drawing No.	Rev.	Date	Page
EL-B02L0300-DSB-D2410W	B	2018/08/22	7/8

Optical Characteristic

Item	EL-B02L0300-DSB-D2410W
Viewing Angle	65°(±10%)
μMol/s*m ² (The center of the amount of survey)	50±20% @ 30cm(center) (without Linear fresnel film)
Light recipe	DSB
CRI	>80

Drawing No.	Rev.	Date	Page
EL-B02L0300-DSB-D2410W	B	2018/08/22	8/8

Fitting Part



Use the illustration:

