





| Drawing No.            | Rev. | Date       | Page |
|------------------------|------|------------|------|
| EL-B01L1200-DSV-D4846W | B    | 2018/08/22 | 1/8  |

# APPROVAL SHEET

Part No: **EL-B01L1200-DSV-D4846W**

**NOTE :**  
**WIDE-BAND**

| MAKER   |   |   | CUSTOMER |          |
|---|---|---|----------|----------|
|  |   |   |          |          |
| R&D   | QA  | Sales   | Checked  | Approved |
|  |  |  |          |          |

|            |            |            |
|------------|------------|------------|
| Prepared   | Checked    | Approved   |
| Rachel Lee | Evan Chang | Kenneth Wu |

| Drawing No.            | Rev. | Date       | Page |
|------------------------|------|------------|------|
| EL-B01L1200-DSV-D4846W | B    | 2018/08/22 | 2/8  |

**Description of P/N No.**

**EL - B01L1200 - DSV - D4846W**

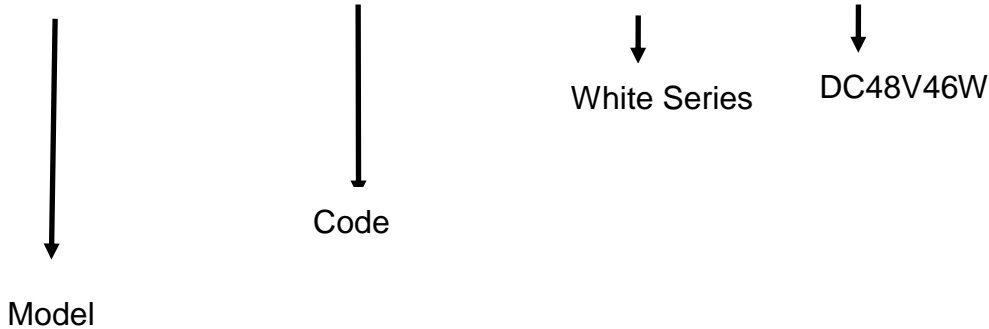

**Description of Lot.**

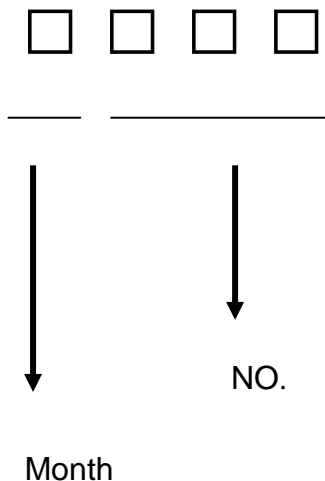

**Solidlite Corp.** 

P/N : \_\_\_\_\_

Lot : \_\_\_\_\_

Date: \_\_\_\_\_ . Rank: \_\_\_\_\_

Q'ty : \_\_\_\_\_ . QA : \_\_\_\_\_

| Drawing No.            | Rev. | Date       | Page |
|------------------------|------|------------|------|
| EL-B01L1200-DSV-D4846W | B    | 2018/08/22 | 3/8  |

## Specification for Approval

**Product :** LED FLAT PANEL

**Part Number :** EL-B01L1200-DSV-D4846W

### Applications

**Area:** Indoor use only

**Purpose:**

Plant Growing Lighting ,Office Lighting , Meeting Room Lighting , Shop Lighting ,  
Classroom Lighting , Factory Lighting ,.....

### Product Overview

※ Aluminum heat-sink base can dissipate more heat and lead to a longer life span.

### Specification ※For Plant Factory use only.

※Remember not to use the device underwater.

**Outline Dimension:** (L)1240 (±4.5mm)mm (W) 100 (±4mm)mm (H) 15.7 (±0.3mm)mm

**Input Voltage /Current :** DC48V/960mA

**Operating Temperature / Relative Humidity:** 0°C~35°C / 20%~80%RH

(Warranty Conditions)

**Storage Temp Range / Relative Humidity:** -20°C ~ 60°C / 20% ~ 80 %RH

**Heat-Sink Surface Temp:** <60 °C

**Life Expectancy of Driver :** 40000hrs

**Life Expectancy of LEDs :**40000hrs

### Safety warning

**Cautions:**

Don't drop the luminaire on the ground since the luminaire will be damaged

Don't expose this product at the high temperature and high humidity environment

### Warranty

Warranty 1years.

Should not have an adverse early.

Within one years, must be greater than the specification brightness light efficiency of 70%.



**Waterproof and dust tight IP66\***

\*Claims and Test Results:The claims are mainly based on results from tests conducted by SGS.(Report No.:OC-2016-300041)

## Chromaticity Coordinate

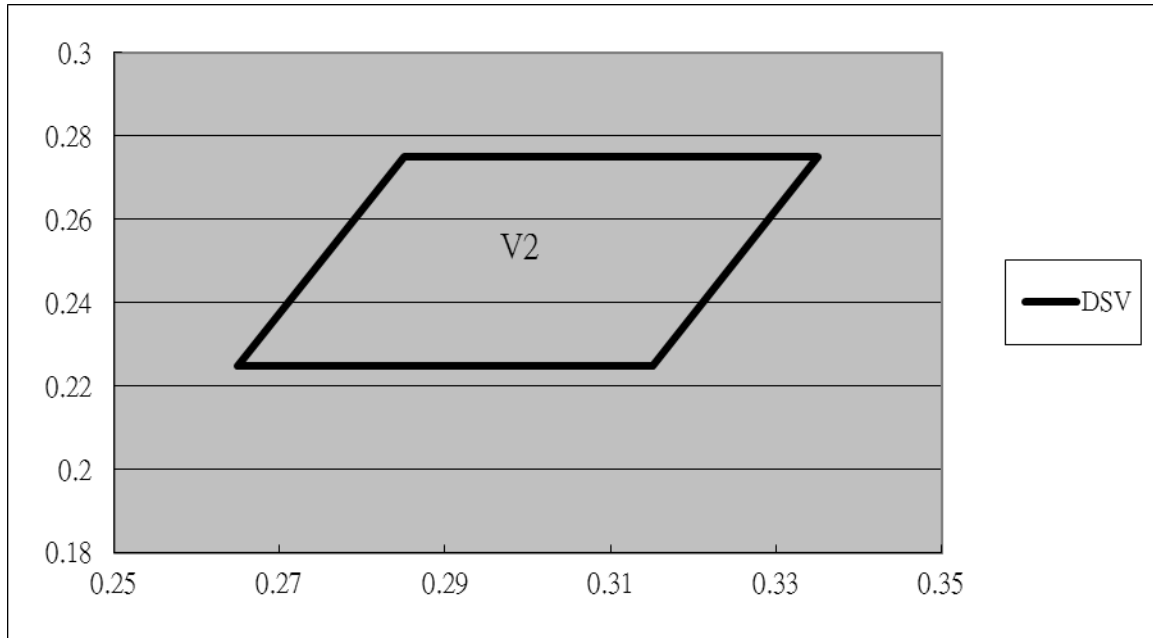

CIE X-Y :

V1---(0.265,0.225) (0.285,0.275) (0.335,275) (0.315,0.225)

## Electronic Charateristic

### Absolute Maximum Ratings at T<sub>a</sub>=25°C

| Item              | EL-B01L1200-DSV-D4846W                   |
|-------------------|--|
| LED Quantity      | 224pcs                                   |
| DC V input        | 48V                                      |
| DC I input        | 960mA                                    |
| Power Dissipation | 46w                                      |
| Heat-Sink Spec.   | Aluminum                                 |
| PCB Spec.         | FR4                                      |
| L/W/H             | 1240mm (±5mm)/100mm(±4mm)/15.7mm(±0.3mm) |
| Net weight        | 1000g±200g                               |

### Product size & Photo

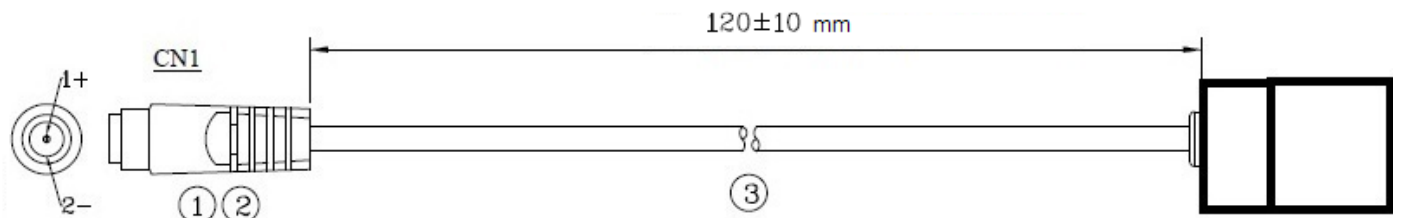
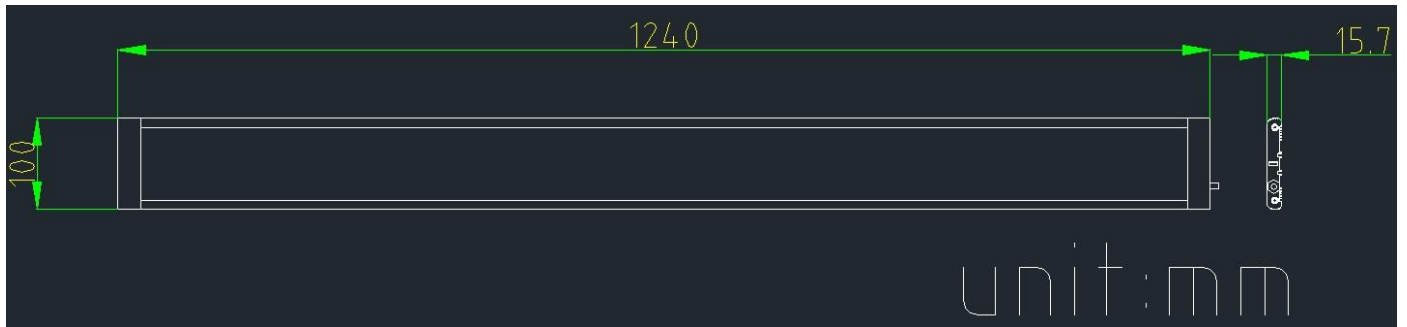

|    |           |                            |      |         |
|----|-----------|----------------------------|------|---------|
| 3  | CABLE     | UL2464#24*2C(STD) OD:3.5mm | 1    | BLACK(0 |
| 2  | PLASTIC   | PVC45P/80°C                |      | BLACK(0 |
| 1  | DC JACK   | (5.5*2.1mm)DC-0236-3       | 1    | 鍍度金泉    |
| NO | PART NAME | PART NO                    | Q'TY | COLOR   |



## Typical Internal Equivalent Circuits

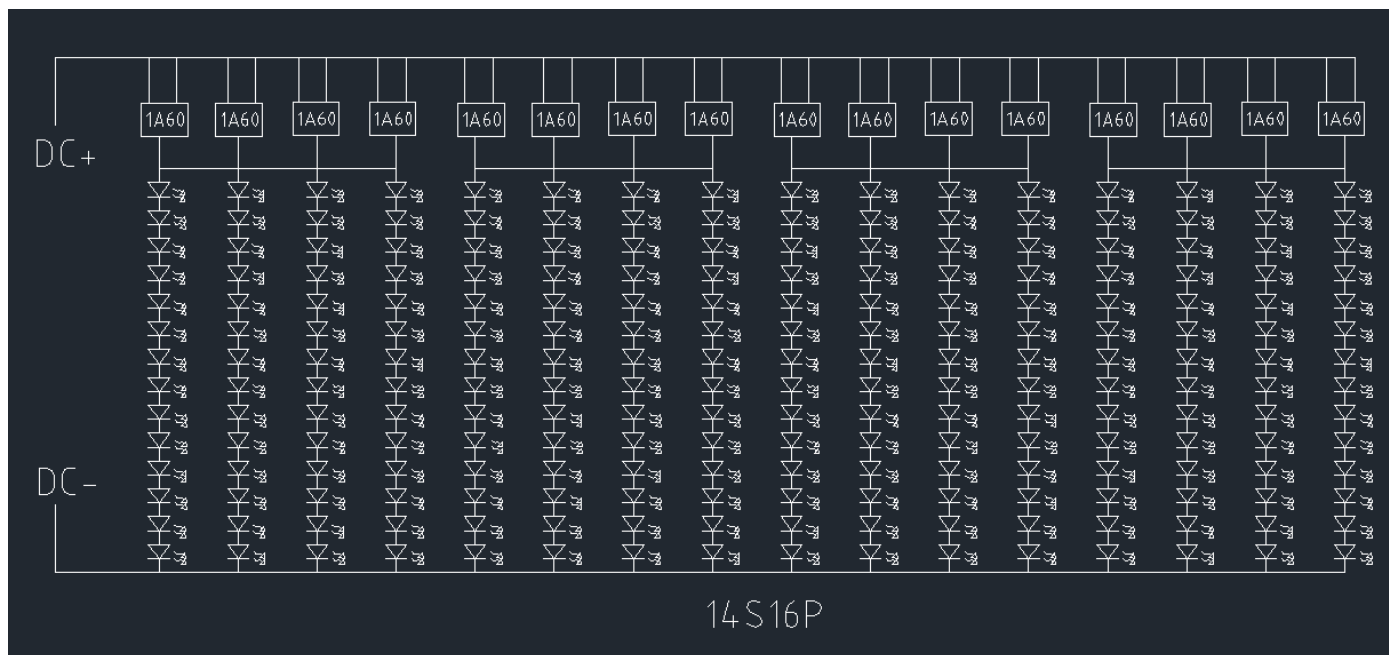

## Label Format

|                                  |  |                               |                               |
|----------------------------------|--|-------------------------------|-------------------------------|
| <b>SOLIDLITE</b><br>詮興開發科技股份有限公司 | <b>EL-B01L1200-DSV-D4846</b><br>LED Flat Panel 48V46W LED平板燈48V46W | 輸入電圧: DC48V<br>消耗功率:<br>輸入電流: | <b>1531</b><br>MADE IN TAIWAN |
|                                  | (Additional label information or specifications)                   |                               |                               |

## Optical Characteristic

| Item  | EL-B01L1200-DSV-D4846W                                 |
|---|--|
| Viewing Angle   | 65°(±10%)  |
| μMol/s*m <sup>2</sup><br>(The center of the amount of survey) | 220±20% @30cm(center)<br>(contain Linear fresnel film) |
| Light recipe  | DSV  |
| CRI   | >80  |

## Package information

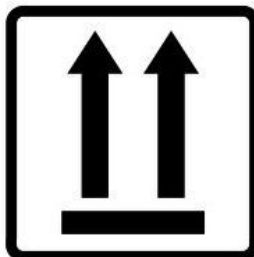
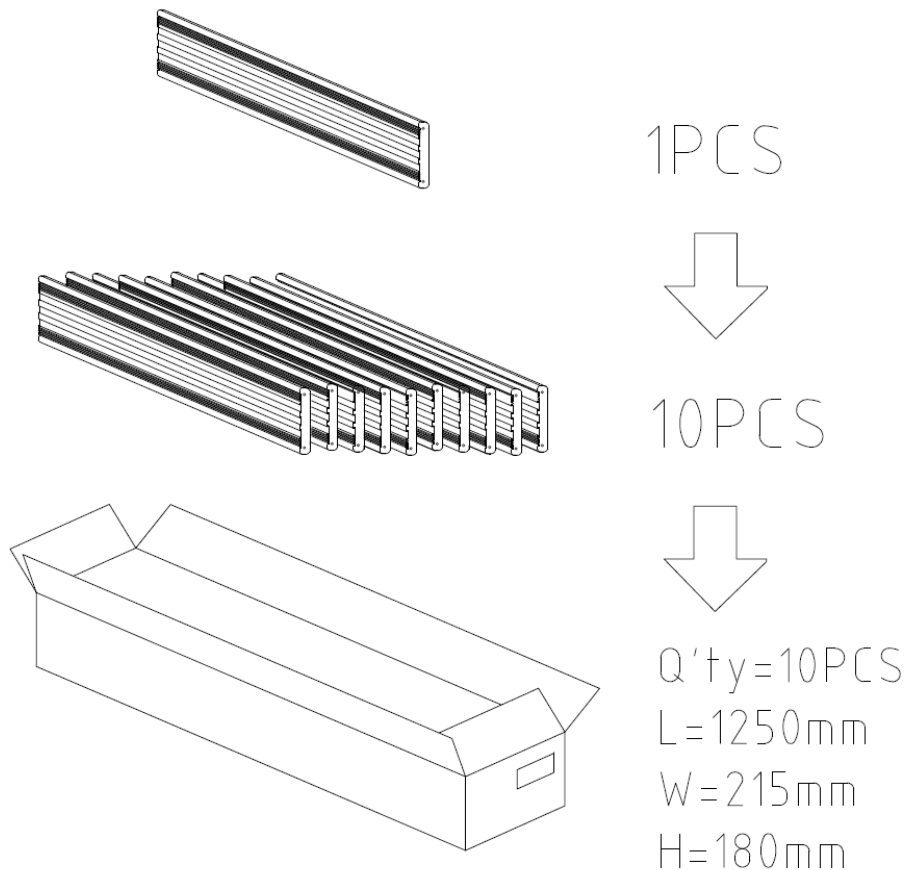



| Drawing No.            | Rev. | Date       | Page |
|------------------------|------|------------|------|
| EL-B01L1200-DSV-D4846W | B    | 2018/08/22 | 8/8  |

**Fitting Part**



**Use the illustration:**

