





Drawing No.	Rev.	Date	Page
EL-B01L1200-DSV-D4830W	B	2018/08/22	1/8

APPROVAL SHEET

Part No: **EL-B01L1200-DSV-D4830W**

NOTE :
WIDE-BAND

MAKER			CUSTOMER	
				
R&D	QA	Sales	Checked	Approved
				

Prepared	Checked	Approved
Rachel Lee	EvanChang	Kenneth Wu

Drawing No.	Rev.	Date	Page
EL-B01L1200-DSV-D4830W	B	2018/08/22	2/8

Description of P/N No.

EL - B01L1200 - DSV - D4830W

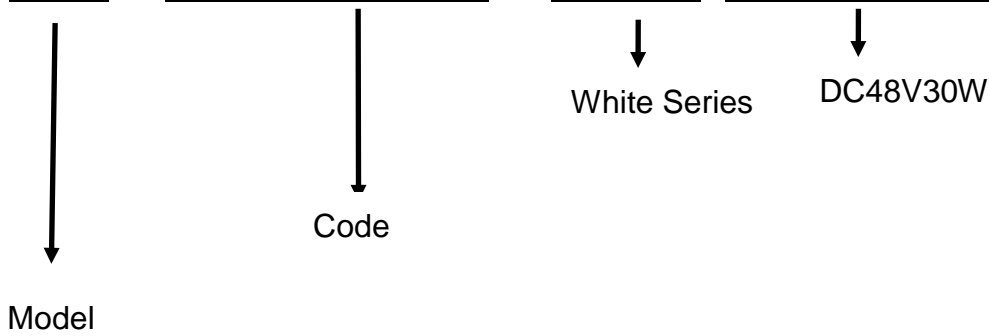

Description of Lot.

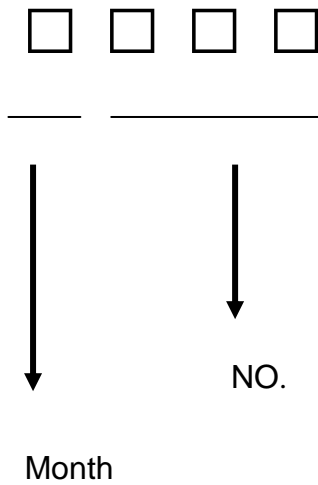

Solidlite Corp. 

P/N : _____

Lot : _____

Date: _____ . Rank: _____

Q'ty : _____ . QA : _____

Drawing No.	Rev.	Date	Page
EL-B01L1200-DSV-D4830W	B	2018/08/22	3/8

Specification for Approval

Product : LED FLAT PANEL

Part Number : EL-B01L1200-DSV-D4830W

Applications

Area: Indoor use only

Purpose:

Plant Growing Lighting ,Office Lighting , Meeting Room Lighting , Shop Lighting ,
Classroom Lighting , Factory Lighting ,.....

Product Overview

※ Aluminum heat-sink base can dissipate more heat and lead to a longer life span.

Specification ※For Plant Factory use only.

※Remember not to use the device underwater.

Outline Dimension: (L)1240 (±4.5mm)mm (W) 100 (±4mm)mm (H) 15.7 (±0.3mm)mm

Input Voltage /Current : DC48V/600mA

Operating Temperature / Relative Humidity: 0°C~35°C / 20%~80%RH

(Warranty Conditions)

Storage Temp Range / Relative Humidity: -20°C ~ 60°C / 20% ~ 80 %RH

Heat-Sink Surface Temp: <60 °C

Life Expectancy of Driver : 40000hrs

Life Expectancy of LEDs :40000hrs

Safety warning

Cautions:

Don't drop the luminaire on the ground since the luminaire will be damaged

Don't expose this product at the high temperature and high humidity environment

Warranty

Warranty 1years.

Should not have an adverse early.

Within one years, must be greater than the specification brightness light efficiency of 70%.



Waterproof and dust tight IP66*

*Claims and Test Results:The claims are mainly based on results from tests conducted by SGS.(Report No.:OC-2016-300041)

Chromaticity Coordinate

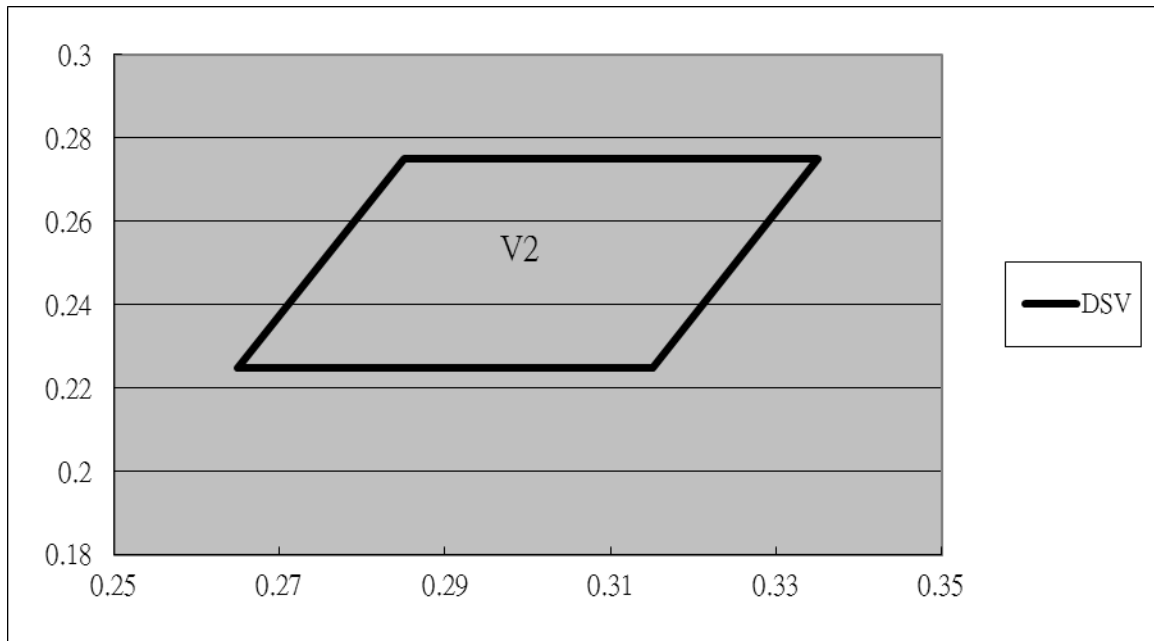

CIE X-Y :

V1---(0.265,0.225) (0.285,0.275) (0.335,275) (0.315,0.225)

Electronic Charateristic

Absolute Maximum Ratings at T_a=25°C

Item	EL-B01L1200-DSV-D4830W
LED Quantity	224pcs
DC V input	48V
DC I input	600mA
Power Dissipation	30w
Heat-Sink Spec.	Aluminum
PCB Spec.	FR4
L/W/H	1240mm (±5mm)/100mm(±4mm)/15.7mm(±0.3mm)
Net weight	1000g±200g

Drawing No.	Rev.	Date	Page
EL-B01L1200-DSV-D4830W	B	2018/08/22	5/8

Product size & Photo

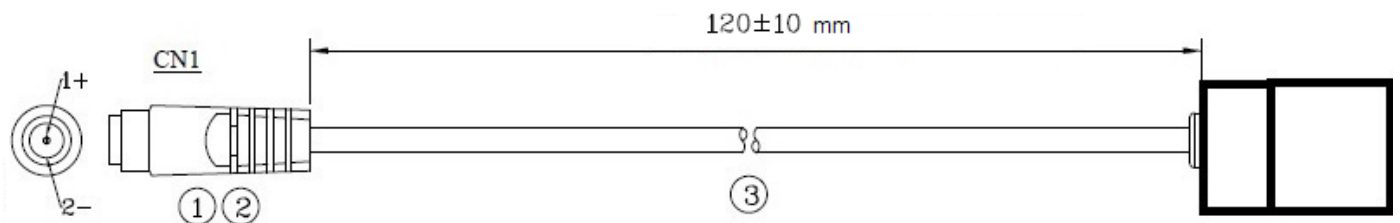
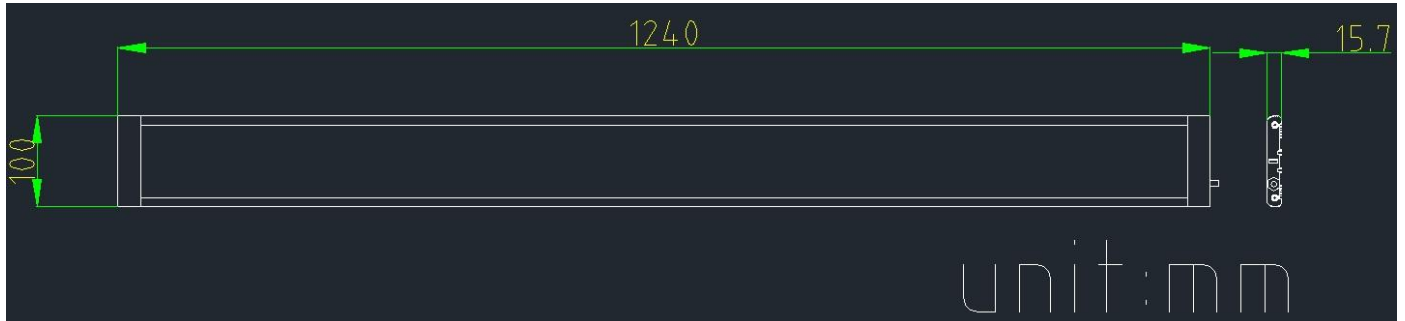

3	CABLE	UL2464#24*2C(STD) OD:3.5mm	1	BLACK(0)
2	PLASTIC	PVC45P/80°C		BLACK(0)
1	DC JACK	(5.5*2.1mm)DC-0236-3	1	金度金泉
NO	PART NAME	PART NO	Q'TY	COLOR



Typical Internal Equivalent Circuits

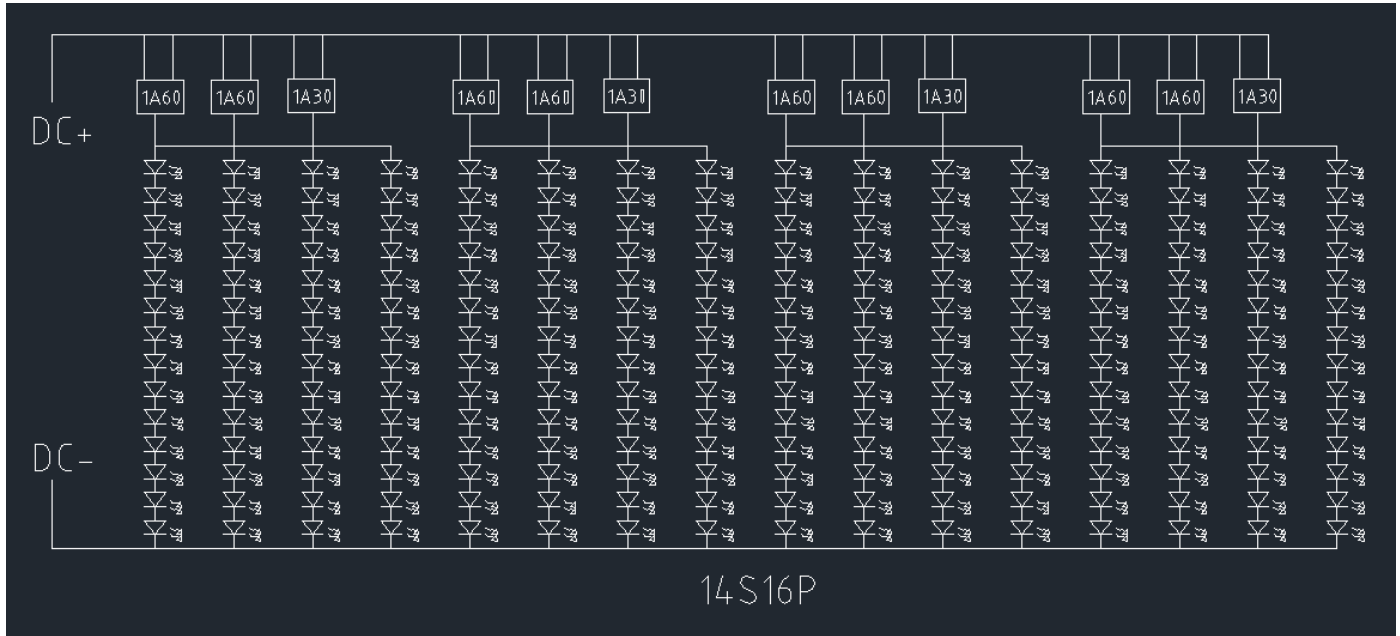

Label Format

SOLIDLITE 詮興開發科技股份有限公司	EL-B01L1200-DSV-D4830 LED Flat Panel 48V30W LED平板燈48V30W	輸入電圧: DC48V 消耗功率: 28.88W 輸入電流: 0.6A	1531 MADE IN TAIWAN
----------------------------------	--	---	-------------------------------

Optical Characteristic

Item	EL-B01L1200-DSV-D4830W
Viewing Angle	65°(±10%)
μMol/s*m ² (The center of the amount of survey)	120±20% @30cm(center) (contain Linear fresnel film)
Light recipe	DSV
CRI	>80

Drawing No.	Rev.	Date	Page
EL-B01L1200-DSV-D4830W	B	2018/08/22	7/8

Package information

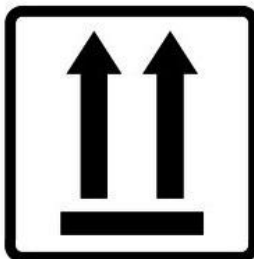
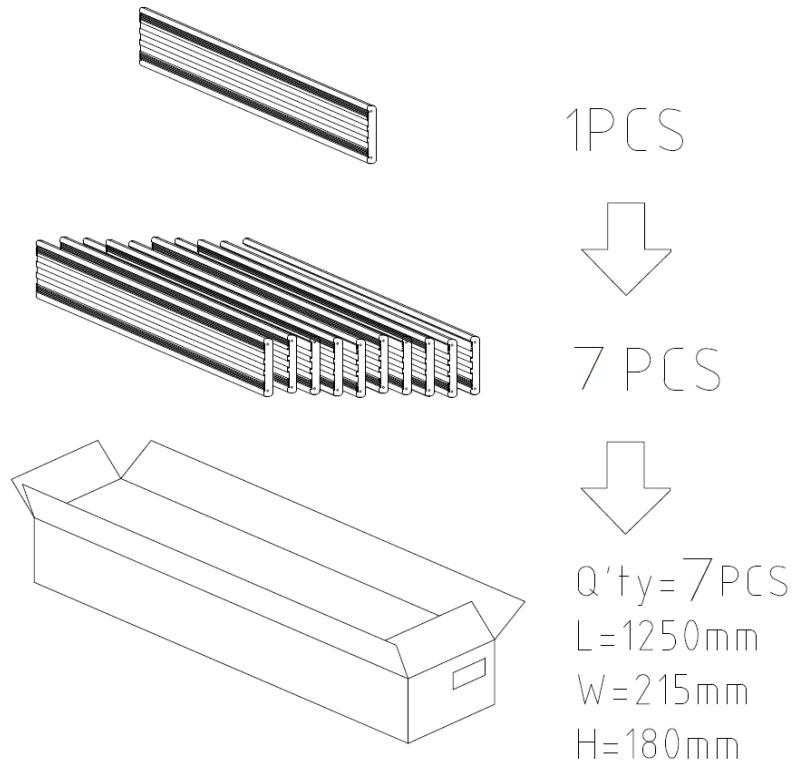

Drawing No.	Rev.	Date	Page
EL-B01L1200-DSV-D4830W	B	2018/08/22	8/8

Fitting Part



Use the illustration:

