

Drawing No.	Rev.	Date	Page
EL-B01L1200-DSC-D4846W	B	2018/08/22	1/9





# APPROVAL SHEET

Part No: **EL-B01L1200-DSC-D4846W**

NOTE :

WIDE-BAND



MAKER			CUSTOMER	
				
R&D	QA	Sales	Checked	Approved
				

Prepared	Checked	Approved
Rachel Lee	Evan Chang	Kenneth Wu

Drawing No.	Rev.	Date	Page
EL-B01L1200-DSC-D4846W	B	2018/08/22	2/9

**Description of P/N No.**

**EL - B01L1200 - DSC - D4846W**

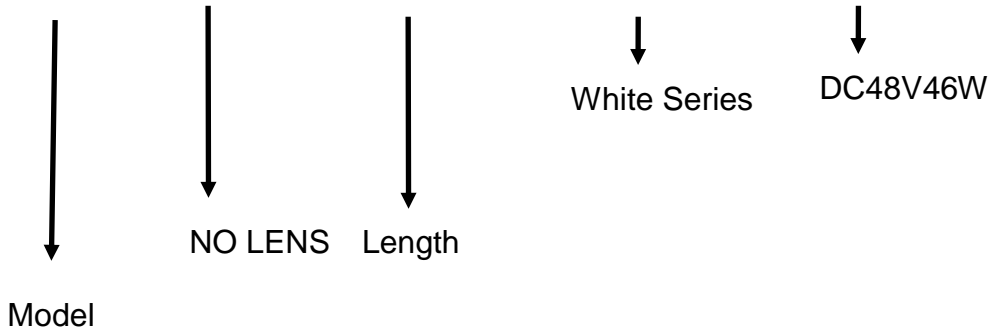

**Description of Lot.**

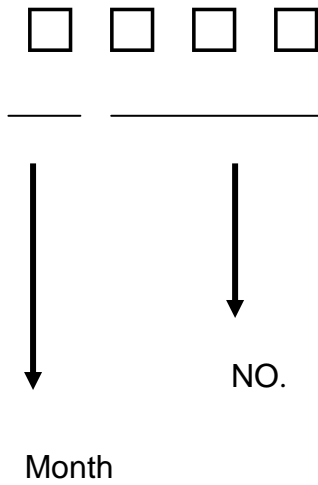

**Solidlite Corp.** 

P/N : \_\_\_\_\_

Lot : \_\_\_\_\_

Date: \_\_\_\_\_ . Rank: \_\_\_\_\_

Q'ty : \_\_\_\_\_ . QA : \_\_\_\_\_

Drawing No.	Rev.	Date	Page
EL-B01L1200-DSC-D4846W	B	2018/08/22	3/9

## Specification for Approval

Product : LED FLAT PANEL

Part Number : EL-B01L1200-DSC-D4846W

### Applications

**Area:** Indoor use only

**Purpose:**

Plant Growing Lighting ,Office Lighting , Meeting Room Lighting , Shop Lighting ,  
Classroom Lighting , Factory Lighting ,.....

### Product Overview

※ Aluminum heat-sink base can dissipate more heat and lead to a longer life span.

**Specification** ※For Plant Factory use only.

※Remember not to use the device underwater.

**Outline Dimension:** (L)1240 (±2.5mm)mm (W) 100 (±2.5mm)mm (H) 15.7 (±0.5mm)mm

**Input Voltage /Current :** DC48V/960mA

**Operating Temperature / Relative Humidity:** 0°C~35°C / 20%~80%RH

(Warranty Conditions)

**Storage Temp Range / Relative Humidity:** -20°C ~ 60°C / 20% ~ 80 %RH

**Heat-Sink Surface Temp:** <60 °C

**Life Expectancy of Driver :** 40000hrs

**Life Expectancy of LEDs :**40000hrs

### **Safety warning**

**Cautions:**

Don't drop the luminaire on the ground since the luminaire will be damaged

Don't expose this product at the high temperature and high humidity environment

### **Warranty**

Warranty 1years.

Should not have an adverse early.

Within 1 years, must be greater than the original brightness light efficiency of 80%.

## Chromaticity Coordinate

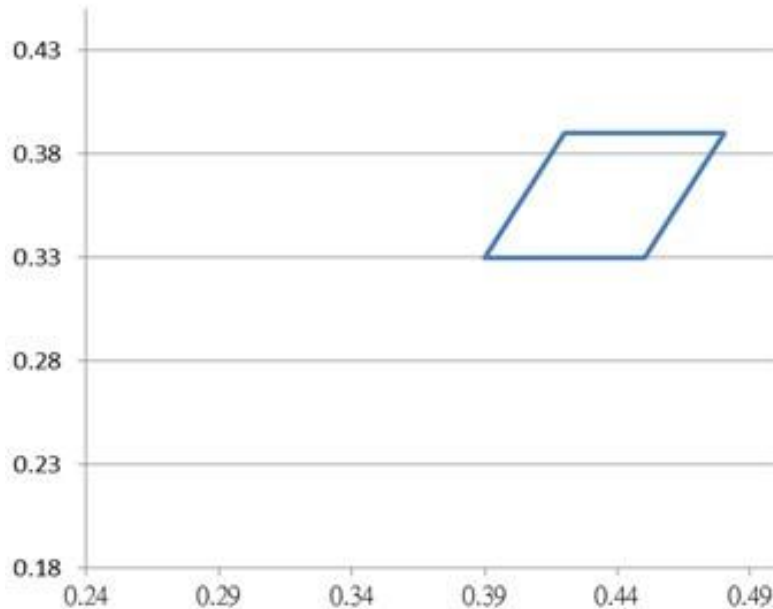

CIE X./Y : DSC --- (0.39, 0.33) (0.42, 0.39) (0.48, 0.39) (0.45, 0.33)

## Electronic Characteristic

### Absolute Maximum Ratings at $T_a=25^{\circ}\text{C}$

Item	EL-B01L1200-DSC-D4846W
LED Quantity	240pcs
DC V input	47~50V
DC I input	960mA±10%
Power Dissipation	46w±10%
Heat-Sink Spec.	Aluminum
PCB Spec.	FR4
L/W/H	1240mm (±2.5mm)/100mm(±2.5mm)/15.7mm(±0.5mm)
Net weight	1350g±50g

Drawing No.	Rev.	Date	Page
EL-B01L1200-DSC-D4846W	B	2018/08/22	5/9

## Product size & Photo

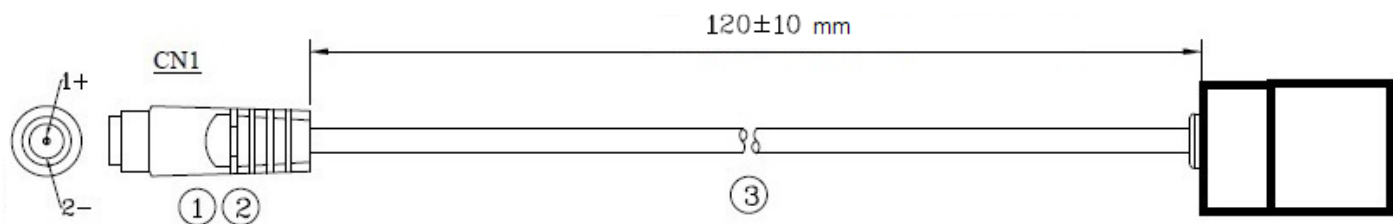

3	CABLE	UL2464#24*2C(STD) OD:3.5mm	1	BLACK(0
2	PLASTIC	PVC45P/80°C		BLACK(0
1	DC JACK	(5.5*2.1mm)DC-0236-3	1	金度金泉
NO	PART NAME	PART NO	Q'TY	COLOR



Drawing No.	Rev.	Date	Page
EL-B01L1200-DSC-D4846W	B	2018/08/22	6/9

## Typical Internal Equivalent Circuits

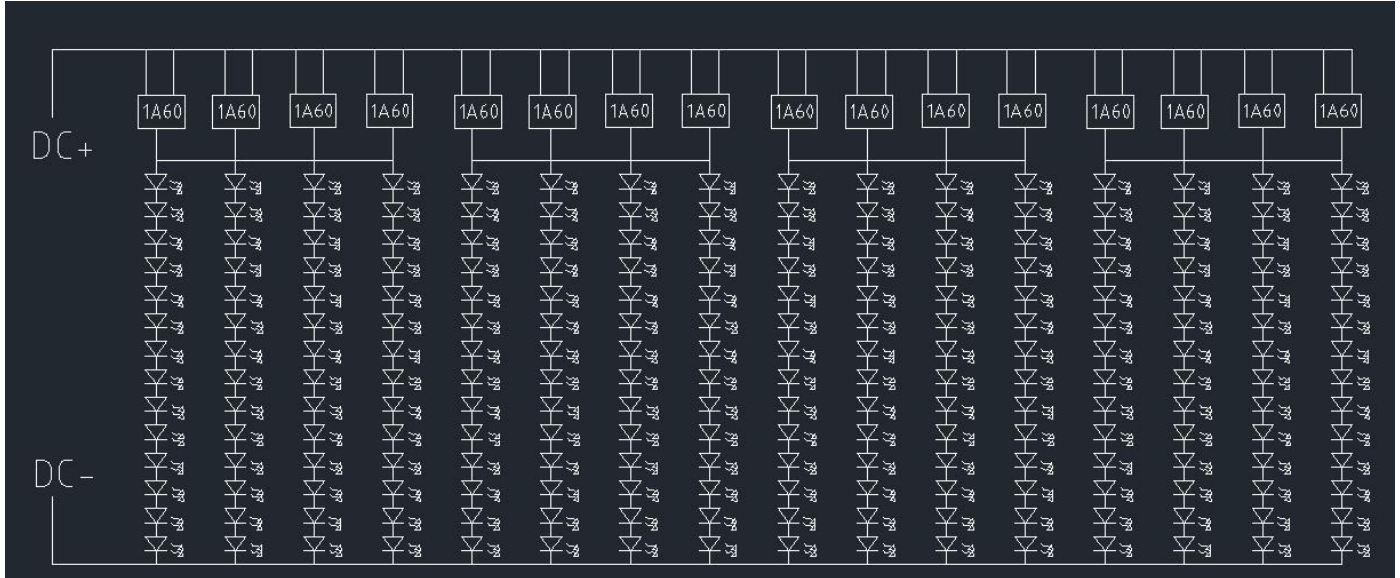

## Label Format

<b>SOLIDLITE</b> 詮興開發科技股份有限公司	<b>EL-B01L1200-DSC-D4846</b> LED Flat Panel 48V46W LED平板燈48V46W	輸入電圧: DC48V 消耗功率: 46.08W 輸入電流: 0.96A	<b>1531</b> MADE IN TAIWAN BM178027 (BG)
		Lot number	CIE Rank

##:Year      ##:Week

## Label Location:

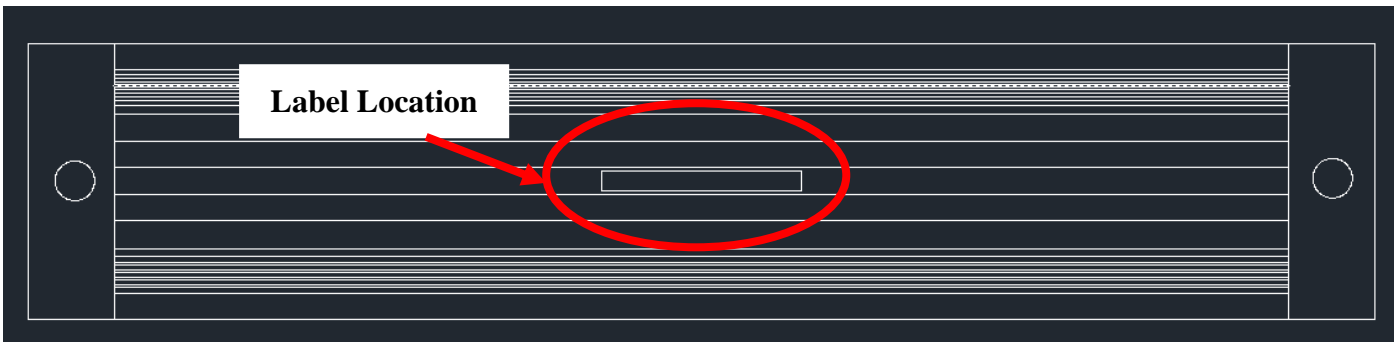

## Optical Characteristic

Item	EL-B01L1200-DSC-D4846W
Viewing Angle	108°(W)~120°(L)
$\mu\text{Mol/s}\cdot\text{m}^2$ (The center of the amount of survey)	220±20% @30cm(center) (without Linear fresnel film) (Measurement device model : HD 2102.2 Made in Italy)
Light recipe	DSC
Dimming & Protection Requirements	According to power supply
Waterproof IP ratings	IP66 *Claims and Test Results:The claims are mainly based on results from tests conducted by SGS.(Report No.:OC-2016-300041)

## Light distribution curve

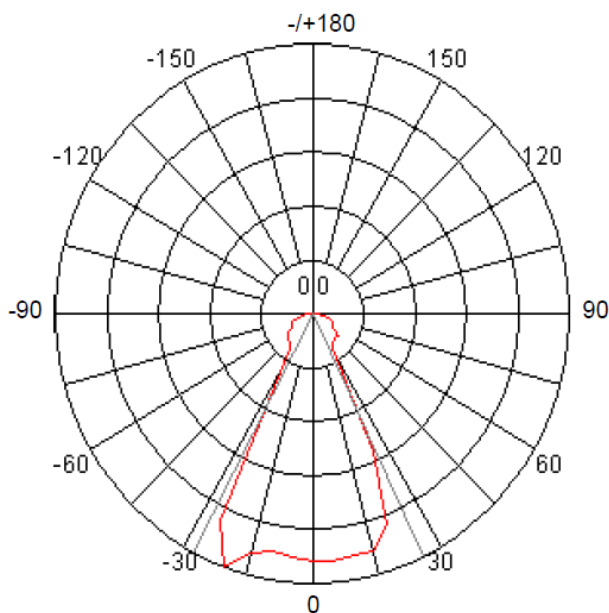

**Average beam angle(50%):53.62°**

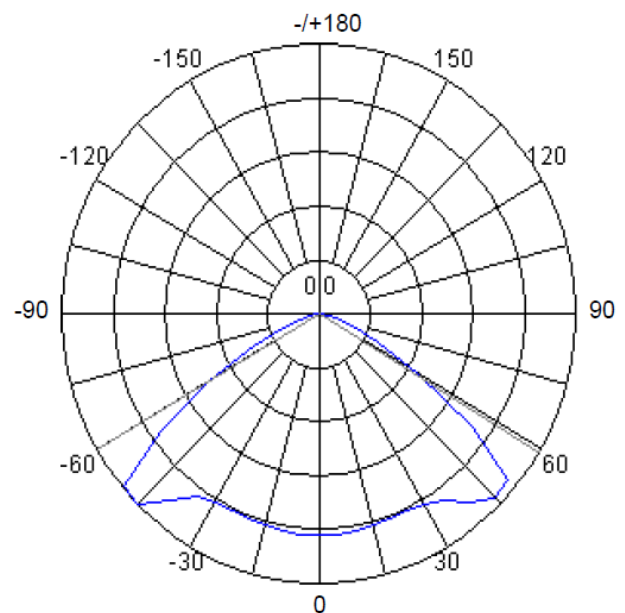

**Average beam angle(50%):119.01°**

Drawing No.	Rev.	Date	Page
EL-B01L1200-DSC-D4846W	B	2018/08/22	8/9

Package information

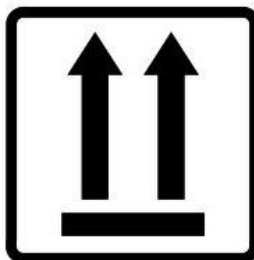
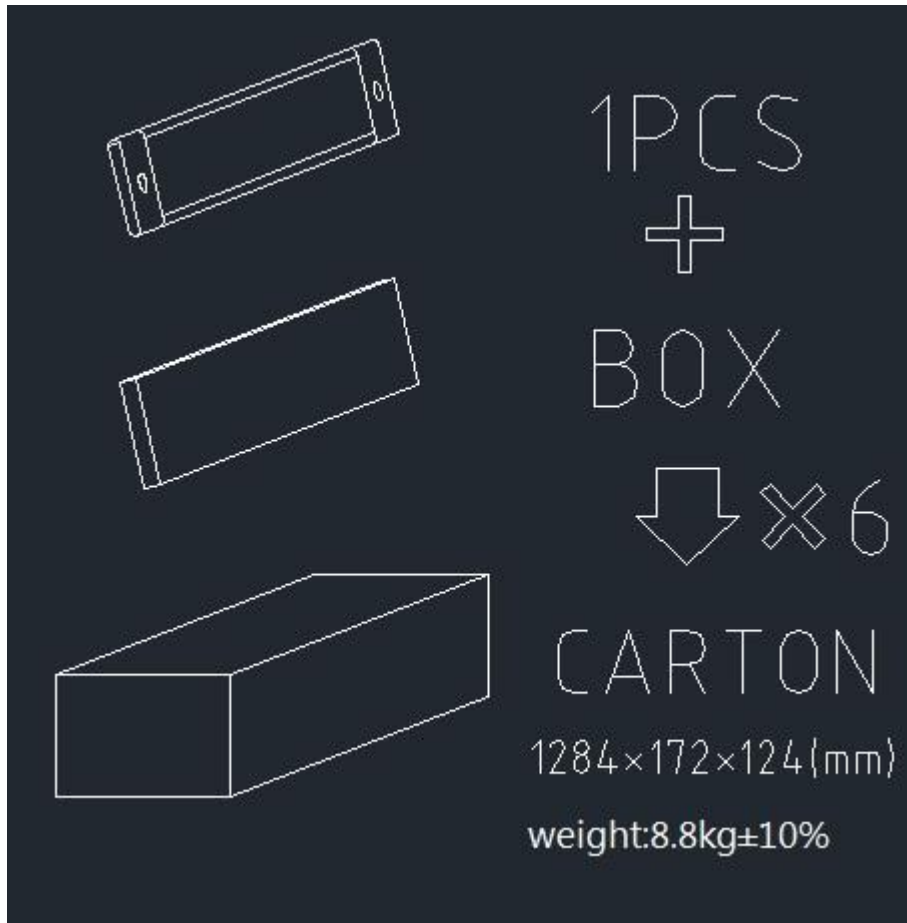



Drawing No.	Rev.	Date	Page
EL-B01L1200-DSC-D4846W	B	2018/08/22	9/9

**Fitting Part**

**L-HOLDER 2set(4PCS)**



**Use the illustration:**

