

Drawing No.	Rev.	Date	Page
EL-B01L0600-DSM-D4846W	A	2019/02/18	1/9





# APPROVAL SHEET

Part No: **EL-B01L0600-DSM-D4846W**

NOTE :

WIDE-BAND



MAKER			CUSTOMER	
				
R&D	QA	Sales	Checked	Approved
				

Prepared	Checked	Approved
Rachel Lee	Evan Chang	Kenneth Wu

Drawing No.	Rev.	Date	Page
EL-B01L0600-DSM-D4846W	A	2019/02/18	2/9

**Description of P/N No.**

**EL - B01L0600 - DSM - D4846W**

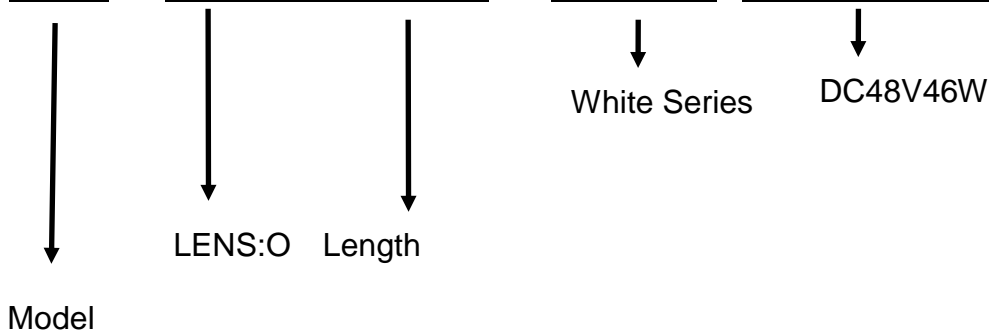

**Description of Lot.**

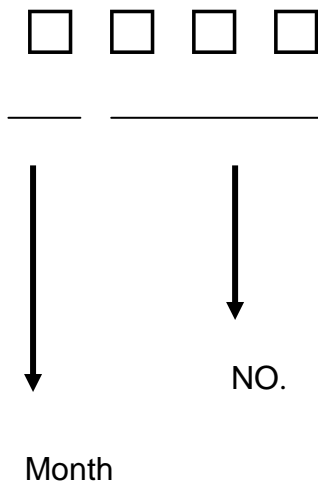

**Solidlite Corp.** 

P/N : \_\_\_\_\_

Lot : \_\_\_\_\_

Date: \_\_\_\_\_ . Rank: \_\_\_\_\_

Q'ty : \_\_\_\_\_ . QA : \_\_\_\_\_

Drawing No.	Rev.	Date	Page
EL-B01L0600-DSM-D4846W	A	2019/02/18	3/9

## Specification for Approval

**Product :** LED FLAT PANEL

**Part Number :** EL-B01L0600-DSM-D4846W

### Applications

**Area:** Indoor use only

**Purpose:**

Plant Growing Lighting ,Office Lighting , Meeting Room Lighting , Shop Lighting ,  
Classroom Lighting , Factory Lighting ,.....

### Product Overview

※ Aluminum heat-sink base can dissipate more heat and lead to a longer life span.

**Specification** ※For Plant Factory use only.

※Remember not to use the device underwater.

**Outline Dimension:** (L)640 (±2.5mm)mm (W) 100 (±2.5mm)mm (H) 15.7 (±0.5mm)mm

**Input Voltage /Current :** DC48V/480mA

**Operating Temperature / Relative Humidity:** 0°C~35°C / 20%~80%RH

(Warranty Conditions)

**Storage Temp Range / Relative Humidity:** -20°C ~ 60°C / 20% ~ 80 %RH

**Heat-Sink Surface Temp:** <60 °C

**Life Expectancy of Driver :** 40000hrs

**Life Expectancy of LEDs :**40000hrs

### Safety warning

**Cautions:**

Don't drop the luminaire on the ground since the luminaire will be damaged

Don't expose this product at the high temperature and high humidity environment

### Warranty

Warranty 1years.

Should not have an adverse early.

Within 1 years, must be greater than the original brightness light efficiency of 70%.

## Chromaticity Coordinate

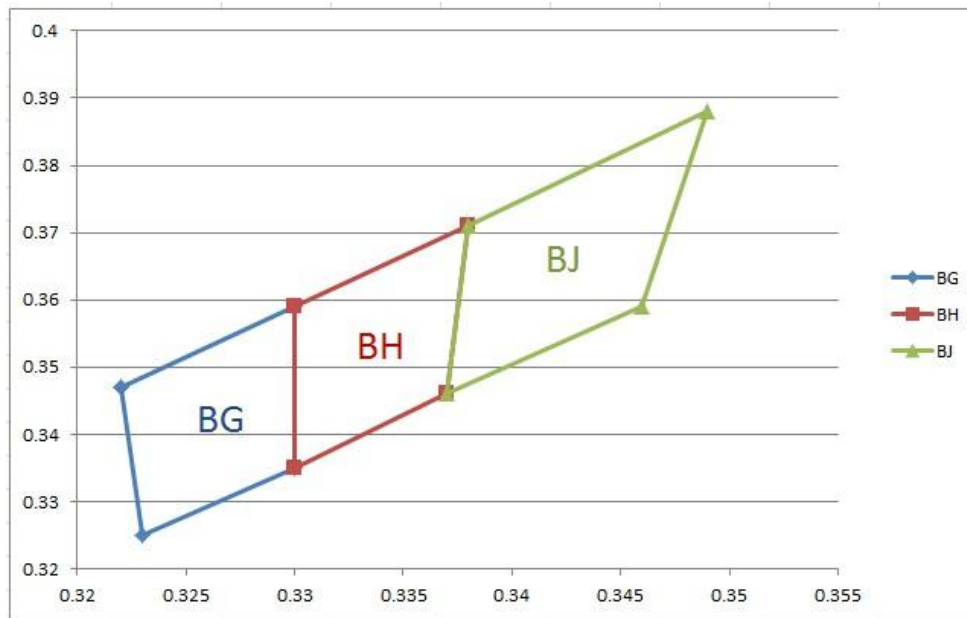

CIE X-Y:

BG: (0.322,0.347)(0.330,0.359)(0.330,0.335)(0.323,0.325)

BH: (0.330,0.359)(0.338,0.371)(0.337,0.346)(0.330,0.335)

BJ: (0.338,0.371)(0.349,0.388)(0.346,0.359)(0.337,0.346)

## Electronic Characteristic

### Absolute Maximum Ratings at $T_a=25^\circ\text{C}$

Item	EL-B01L0600-DSM-D4846W
LED Quantity	280pcs
DC V input	47~50V
DC I input	960mA $\pm$ 10%
Power Dissipation	46w $\pm$ 10%
Heat-Sink Spec.	Aluminum
PCB Spec.	MCPCB
L/W/H	640mm ( $\pm$ 2.5mm)/100mm( $\pm$ 2.5mm)/15.7mm( $\pm$ 0.5mm)
Net weight	700g $\pm$ 50g

Drawing No.	Rev.	Date	Page
EL-B01L0600-DSM-D4846W	A	2019/02/18	5/9

### Product size & Photo

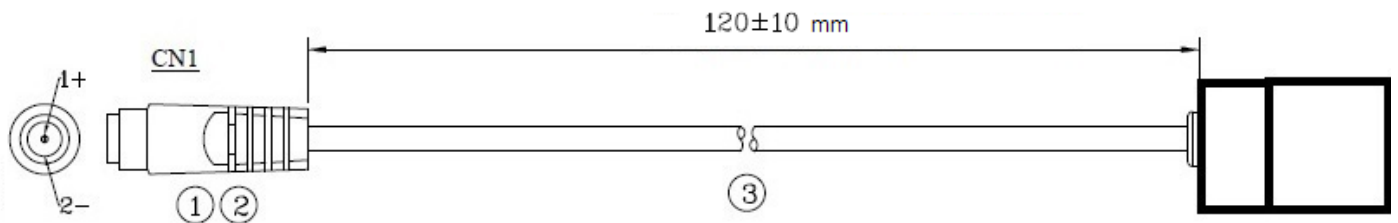

3	CABLE	UL2464#24*2C(STD) OD: 3.5mm	1	BLACK(0)
2	PLASTIC	PVC45P/80°C		BLACK(0)
1	DC JACK	(5.5*2.1mm)DC-0236-3	1	金度金泉
NO	PART NAME	PART NO	Q'TY	COLOR



Drawing No.	Rev.	Date	Page
EL-B01L0600-DSM-D4846W	A	2019/02/18	6/9

## Typical Internal Equivalent Circuits

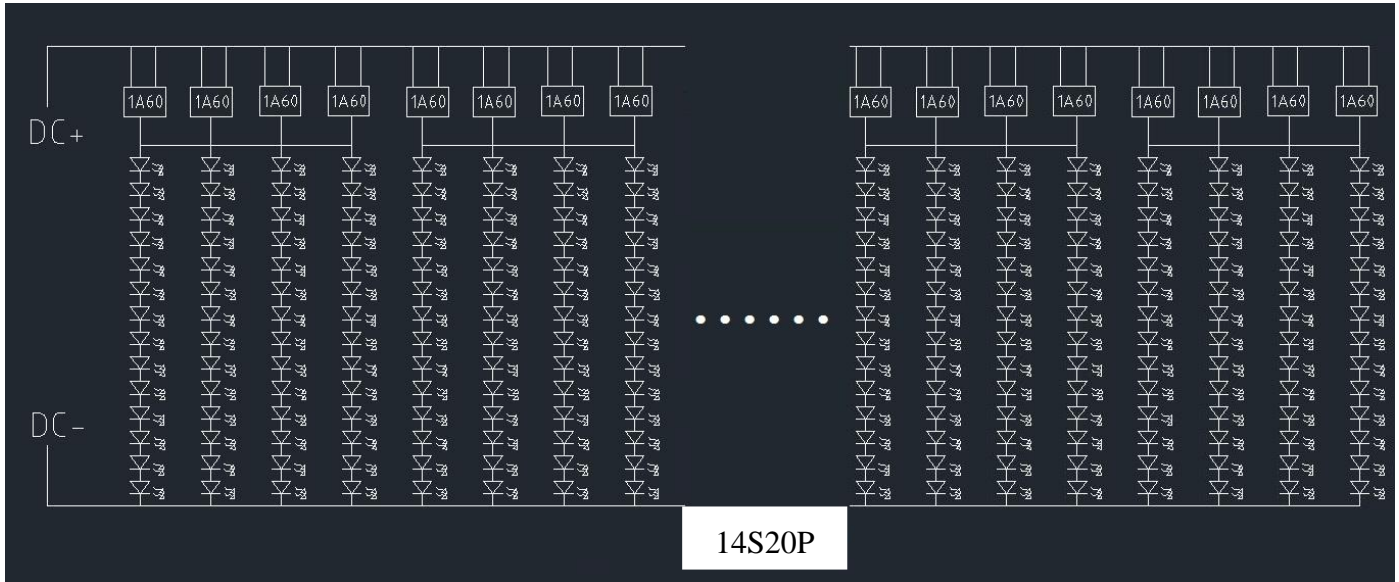

## Label Format

<b>SOLIDLITE</b> 詮興開發科技股份有限公司	<b>EL-B01L0600-DSM-D4846</b> LED Flat Panel 48V	<b>LED平板燈48V</b>	輸入電圧: DC48V 消耗功率: 輸入電流:	<b>1531</b> MADE IN TAIWAN
----------------------------------	--	------------------	-------------------------------	-------------------------------

## Label Location:

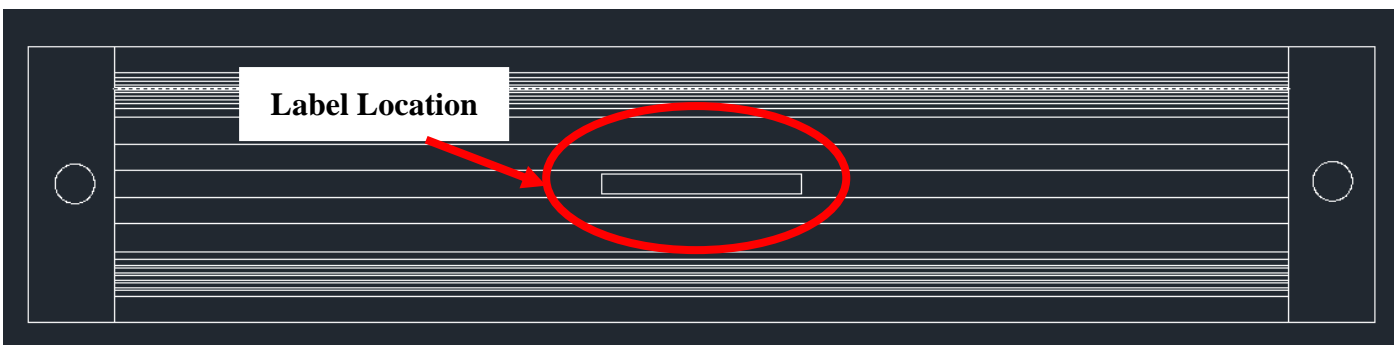

## Optical Characteristic

Item	EL-B01L0600-DSM-D4846W
Viewing Angle	65°((±10%)
$\mu\text{Mol/s}\cdot\text{m}^2$ (The center of the amount of survey)	>300@30cm(center) (with Linear fresnel film) (Measurement device model : HD 2102.2 Made in Italy)
Light recipe	DSM
Dimming & Protection Requirements	According to power supply
Waterproof IP ratings	IP66 *Claims and Test Results:The claims are mainly based on results from tests conducted by SGS.(Report No.:OC-2016-300041)

## Light distribution curve

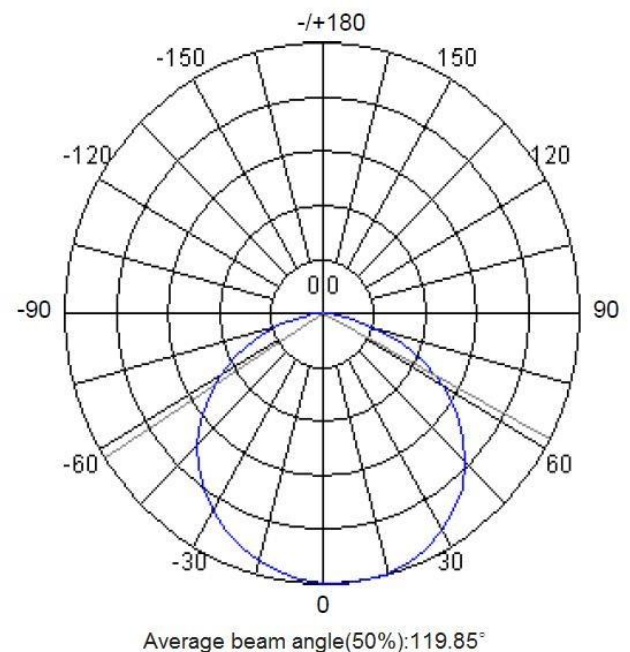
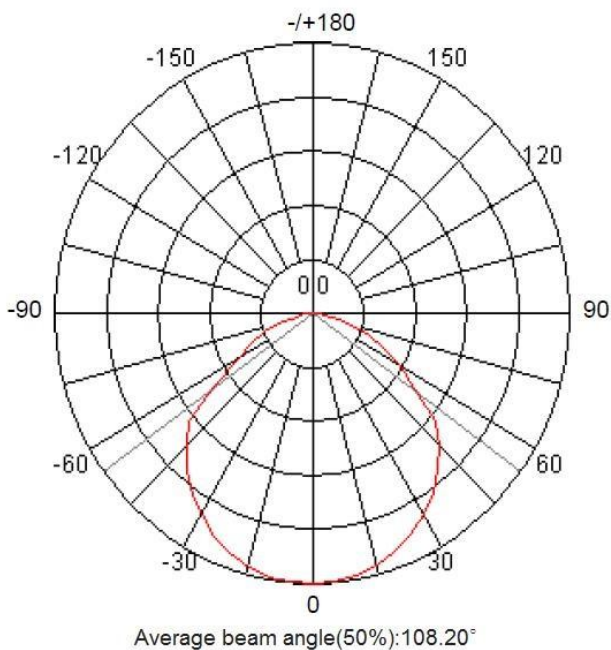

Drawing No.	Rev.	Date	Page
EL-B01L0600-DSM-D4846W	A	2019/02/18	8/9

Package information

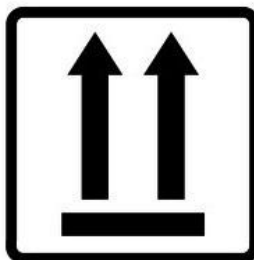
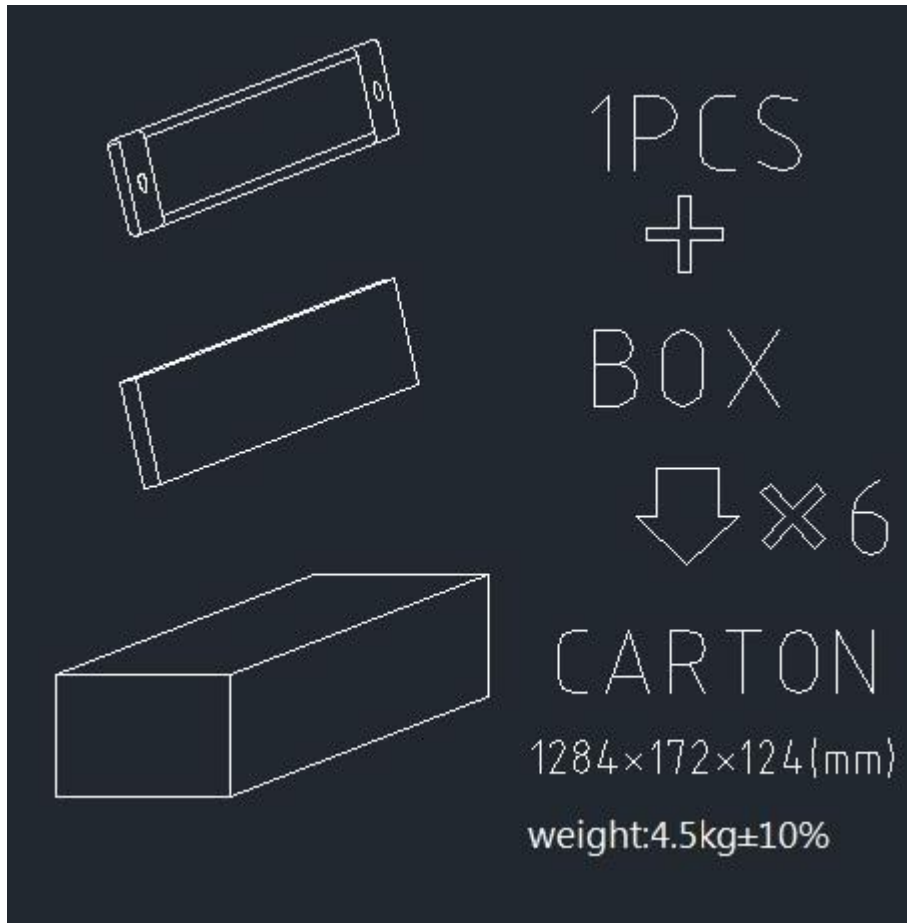



Drawing No.	Rev.	Date	Page
EL-B01L0600-DSM-D4846W	A	2019/02/18	9/9

**Fitting Part**

**L-HOLDER 2set(4PCS)**



**Use the illustration:**

