



Drawing No.	Rev.	Date	Page
EL-B01L0300-DSV-D2410W	B	2018/08/22	1/8

# APPROVAL SHEET

Part No: **EL-B01L0300-DSV-D2410W**

**NOTE :**  
**WIDE-BAND**

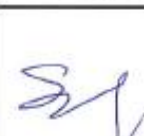
MAKER			CUSTOMER	
				
R&D	QA	Sales	Checked	Approved
				

Prepared	Checked	Approved
Rachel Lee	EvanChang	Kenneth Wu

Drawing No.	Rev.	Date	Page
EL-B01L0300-DSV-D2410W	B	2018/08/22	2/8

**Description of P/N No.**

**EL - B01L0300 - DSV - D2410W**

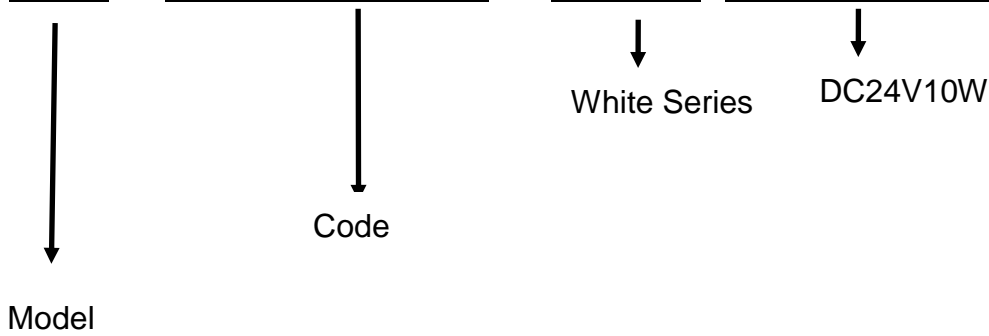

**Description of Lot.**

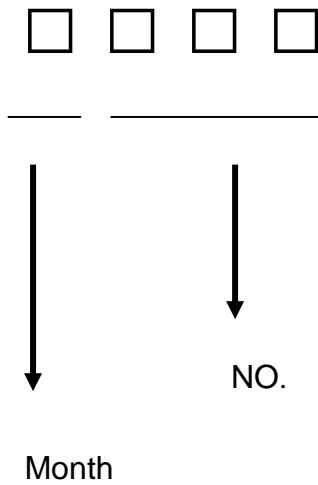

**Solidlite Corp.** 

P/N : \_\_\_\_\_

Lot : \_\_\_\_\_

Date: \_\_\_\_\_ . Rank: \_\_\_\_\_

Q'ty : \_\_\_\_\_ . QA : \_\_\_\_\_

Drawing No.	Rev.	Date	Page
EL-B01L0300-DSV-D2410W	B	2018/08/22	3/8

## Specification for Approval

**Product :** LED FLAT PANEL

**Part Number :** EL-B01L0300-DSV-D2410W

### Applications

**Area:** Indoor use only

**Purpose:**

Plant Growing Lighting , Office Lighting , Meeting Room Lighting , Shop Lighting ,  
Classroom Lighting , Factory Lighting , .....

### Product Overview

※ Aluminum heat-sink base can dissipate more heat and lead to a longer life span.

### Specification ※For Plant Factory use only.

※Remember not to use the device underwater.

**Outline Dimension:** (L)300 (±5mm)mm (W) 100 (±4mm)mm (H) 15.7 (±0.3mm)mm

**Input Voltage /Current :** DC24V/400mA

**Operating Temperature / Relative Humidity:** 0°C~35°C / 20%~80%RH  
(Warranty Conditions)

**Storage Temp Range / Relative Humidity:** -20°C ~ 60°C / 20% ~ 80 %RH

**Heat-Sink Surface Temp:** <60 °C

**Life Expectancy of Driver :** 40000hrs

**Life Expectancy of LEDs :**40000hrs

### Safety warning

**Cautions:**

Don't drop the luminaire on the ground since the luminaire will be damaged

Don't expose this product at the high temperature and high humidity environment

### Warranty

Warranty 1years.

Should not have an adverse early.

Within one years, must be greater than the specification brightness light efficiency of 70%.



**Waterproof and dust tight IP66\***

\*Claims and Test Results:The claims are mainly based on results from tests conducted by SGS.(Report No.:OC-2016-300041)

## Chromaticity Coordinate

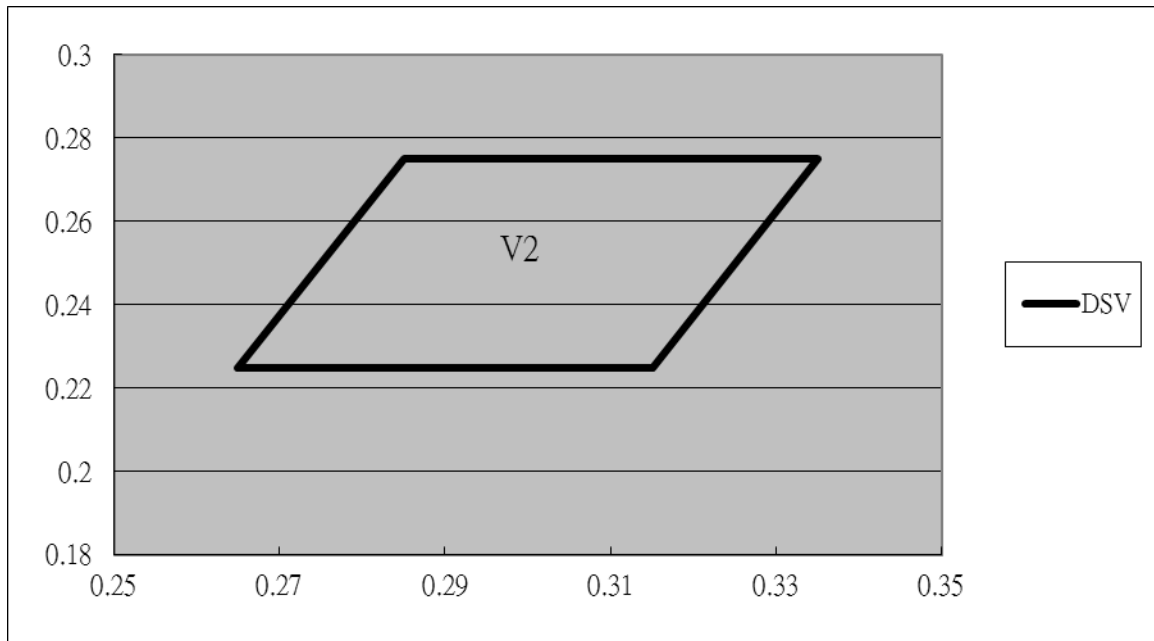

CIE X-Y :

V1---(0.265,0.225) (0.285,0.275) (0.335,275) (0.315,0.225)

## Electronic Charateristic

### Absolute Maximum Ratings at T<sub>a</sub>=25°C

Item	EL-B01L0300-DSV-D2410W
LED Quantity	84pcs
DC V input	24V
DC I input	400mA
Power Dissipation	10w
Heat-Sink Spec.	Aluminum
PCB Spec.	FR4
L/W/H	300mm (±5mm)/100mm(±4mm)/15.7mm(±0.3mm)
Net weight	300g±50g

Drawing No.	Rev.	Date	Page
EL-B01L0300-DSV-D2410W	B	2018/08/22	5/8

**Product size & Photo**

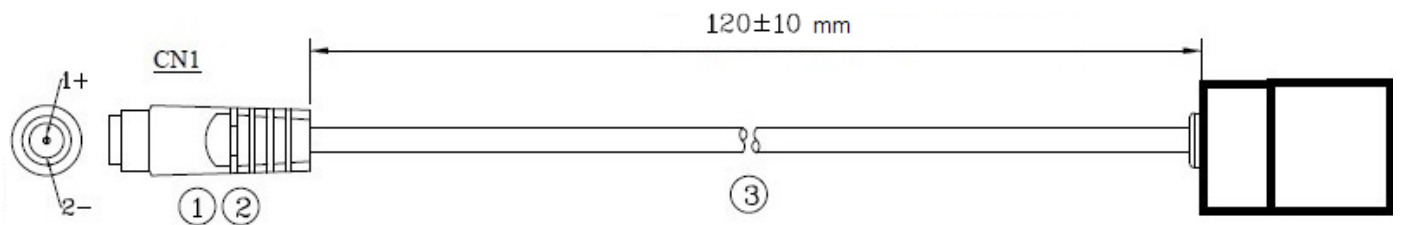
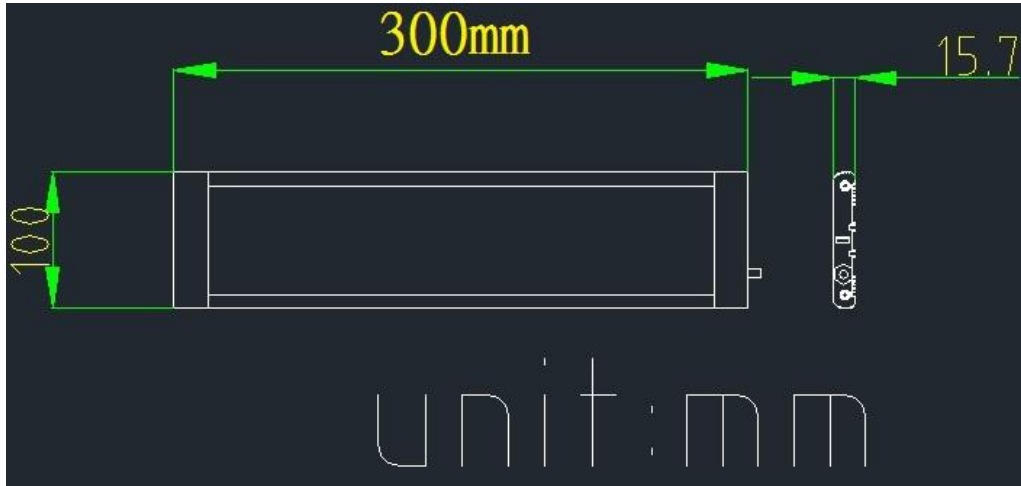

3	CABLE	UL2464#24*2C(STD) OD:3.5mm	1	BLACK(0
2	PLASTIC	PVC45P/80°C		BLACK(0
1	DC JACK	(5.5*2.1mm)DC-0236-3	1	鍍度金泉
NO	PART NAME	PART NO	Q'TY	COLOR



Drawing No.	Rev.	Date	Page
EL-B01L0300-DSV-D2410W	B	2018/08/22	6/8

## Typical Internal Equivalent Circuits

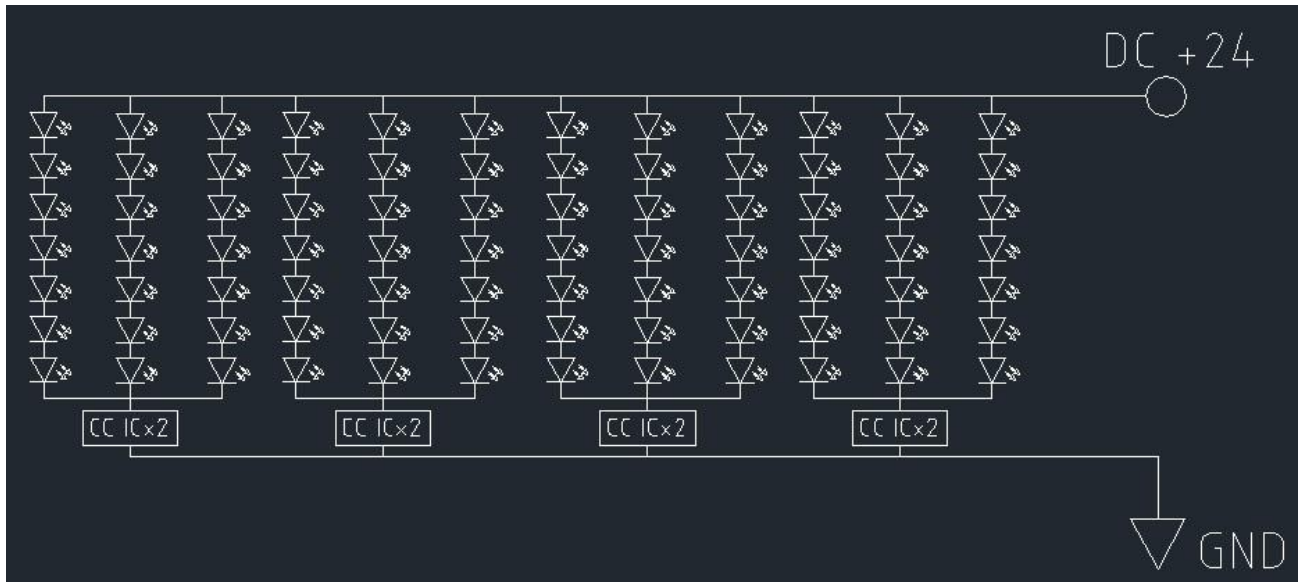

## Label Format

<b>SOLIDLITE</b> 詮興開發科技股份有限公司	<b>EL-B01L0300-DSV-D2410</b> LED Flat Panel <b>2410W</b> LED平板燈 <b>2410W</b>	輸入電壓DC24V <b>1531</b> 消耗功率10W 輸入電流: <span style="border: 1px solid black; padding: 2px;">1531</span> MADE IN TAIWAN
----------------------------------	---	--

Drawing No.	Rev.	Date	Page
EL-B01L0300-DSV-D2410W	B	2018/08/22	7/8

## Optical Characteristic

Item	EL-B01L0300-DSV-D2410W
Viewing Angle	65°(±10%)
$\mu\text{Mol/s}\cdot\text{m}^2$ (The center of the amount of survey)	80±20% @ 30cm(center) (contain Linear fresnel film)
Light recipe	DSV
CRI	>80

Drawing No.	Rev.	Date	Page
EL-B01L0300-DSV-D2410W	B	2018/08/22	8/8

**Fitting Part**



**Use the illustration:**

